

GeoMax ZT20 Series

User Manual

Version 1.0

GEOMAX
Part of Hexagon Group



Congratulations on the purchase of a GeoMax ZT20 instrument



This manual contains important safety directions as well as instructions for setting up the product and operating it. Refer to “10 Safety Directions” for further information.



Read carefully the User Manual before you switch on the product.

Product identification

The type and serial number of your product are indicated on the type plate. Enter the type and serial number in your manual and always refer to this information when you need to contact your agency or GeoMax authorised service workshop.

Type _____

Serial No. _____

Symbols

The symbols used in this manual have the following meanings:



Danger - Indicates an imminently hazardous situation which, if not avoided, will result in death or serious injury.



Warning - Indicates a potentially hazardous situation or an unintended use which, if not avoided, could result in death or serious injury.



Caution - Indicates a potentially hazardous situation or an unintended use which, if not avoided, may result in minor or moderate injury and/or appreciable material, financial and environmental damage.



Important paragraphs which must be adhered to in practice as they enable the product to be used in a technically correct and efficient manner.

Trademarks

Windows is a registered trademark of Microsoft Corporation.

All other trademarks are the property of their respective owners.

Table of Contents

1	Description of the System	
	Welcome.....	2
	Instrument Components.....	8
	Glossary.....	10
	GeoMax Office Tools	13
	Power Supply	16
2	Instrument setup	
	Container Contents.....	18
	Working with the Battery.....	19
	Level/Plummet.....	21
	Input Mode.....	23
	Distance Measurements.....	25
3	Operation	
	Keyboard.....	29
	Functions.....	34
	Status Icons.....	35
4	Quick-Survey	
	Angle Measurements.....	38

	Distance measurements.....	42
	Coordinates measurements.....	45
5	Applications	
	Pre-settings.....	47
	Data Collection.....	51
	Set out.....	54
	Missing line.....	61
	Resection.....	64
	Area.....	69
	Remote Elevation.....	71
6	Data Management	
	Job.....	74
	Known Points.....	75
	Observations.....	76
	Code Library.....	76
	Memory Initialization.....	77
	Memory Information.....	77
7	Configurations	
	General Configuration.....	79
	EDM Configuration.....	84
	System Information.....	88

8	Calibration	
	Overview.....	90
	Preparation.....	91
	Program calibration.....	92
	Inspecting Laser Plummet.....	96
9	Care and Transport	
	Transport.....	99
	Storage.....	100
	Cleaning and Drying.....	102
10	Safety Directions	
	Intended Use.....	106
	Responsibilities.....	107
	Hazards of Use.....	108
	Laser Classification.....	114
	Electromagnetic Compatibility EMC.....	122
11	Technical Data	
	General.....	129
	Scale Correction.....	135
	Reduction Formulas.....	138

Introduction

Contents:

- Welcome
- Instrument components
- Glossary
- GeoMax Office Tools
- Power Supply

Chapter 1

Instrument components



Objective with
integrated
Electronic Distance
Measurement(EDM)

Tilting axis (Horizontal axis indicator)

GeoMax brand label

Display



Glossary

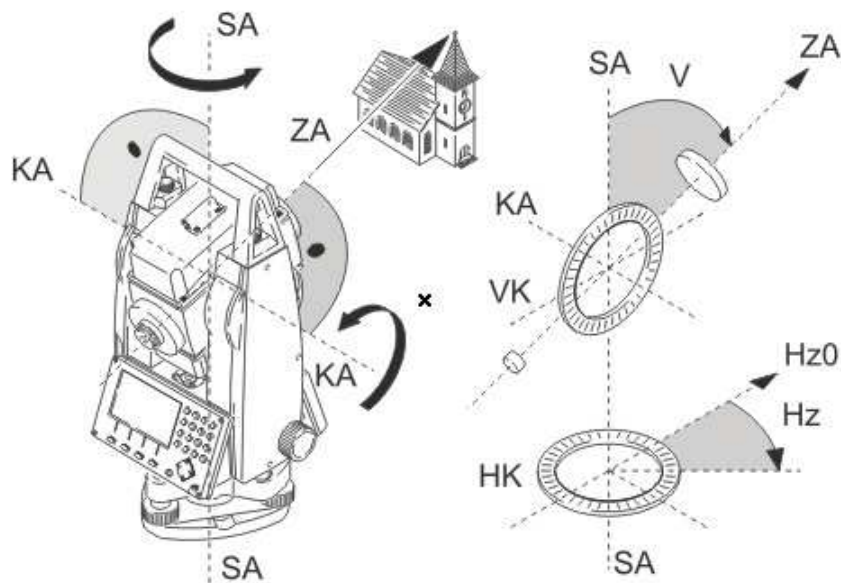

ZA Line of sight / collimation axis
Line from the cross hairs to the center of the objective.

SA Standing axis
Vertical rotation axis of the telescope.

KA Tilting axis
Horizontal rotation axis of telescope.
Also known as Trunnion axis.

V Vertical angle / zenith angle

VK Vertical circle
With coded circular division for reading the vertical angle.

Hz Horizontal direction

HK Horizontal circle
With coded circular division for reading the horizontal angle.

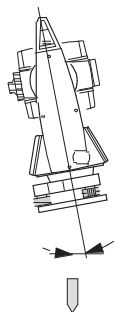

Standing axis inclination

Angle between plumb line and standing axis. Standing axis tilt is not an instrument error and is not eliminated by measuring in both faces. Any possible influence it may have on the horizontal direction or vertical angles is eliminated by the dual axis compensator.

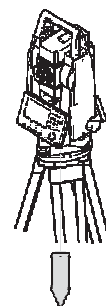

Plumb line / compensator

Direction of gravity. The compensator defines the plumb line within the instrument.

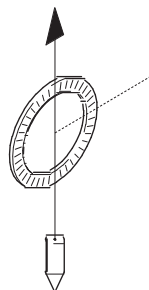

Zenith

Point on the plumb line above the observer.

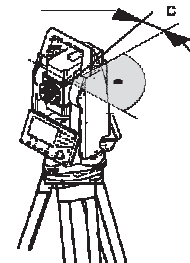

Line-of-sight error

The line-of-sight error (c) is the deviation from the perpendicular between the tilting axis and line of sight. This could be eliminated by measuring in both faces.

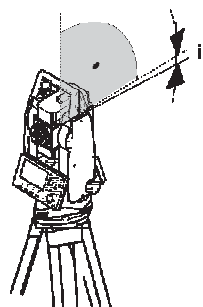

Vertical index error

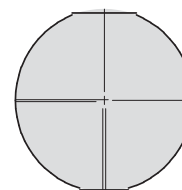

With a horizontal line of sight the vertical circle reading should be exactly 90° . The deviation from this value is termed the Vertical index error (i).

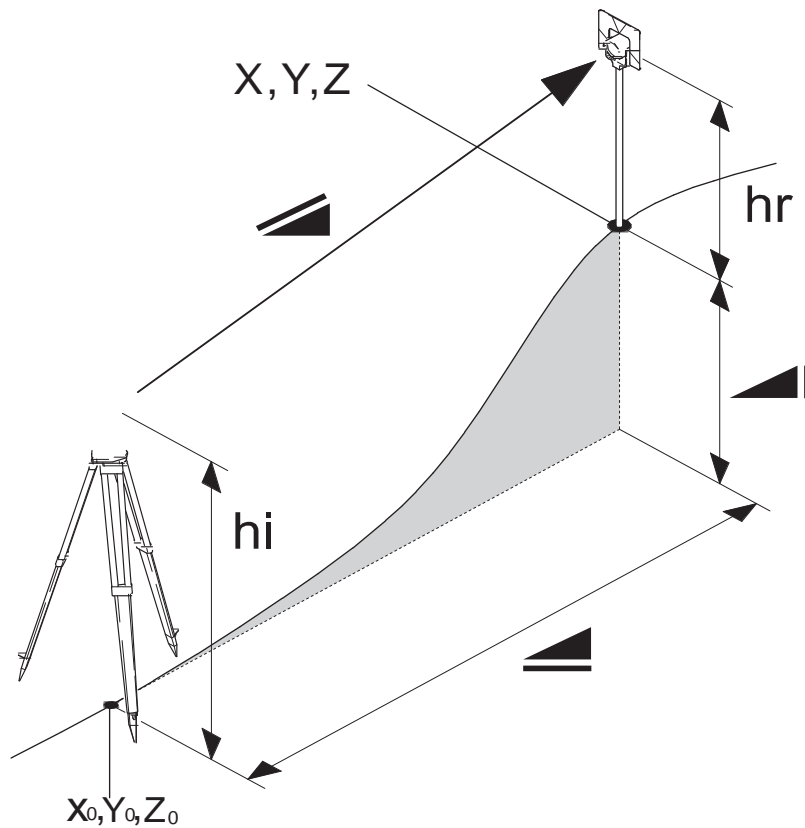

Crosshairs

Glass plate within the telescope with crosshair.



-  Indicated meteorological corrected slope distance between instrument tilting axis and center of prism / laser dot
-  Indicated meteorological corrected horizontal distance
-  Height difference between station and target point
- hr** Reflector height above ground
- hi** Instrument height above ground
- X₀** X coordinate of station
- Y₀** Y coordinate of station
- Z₀** Z coordinate of station
- X** X coordinate of target point
- Y** Y coordinate of target point
- Z** Z coordinate of target point

GeoMax Office Tools

GeoMax Office Tools is used for data exchange between total station and computer/laptop.

Installation

You will find the installation program in the supplied CD/DVD, it runs under Windows 98/Windows 2000/Windows XP OS.

Contents

GeoMax Office Tool consists of the following applications:

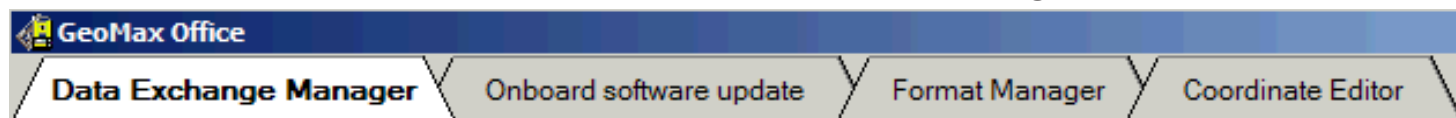

- **Data exchange manager**

Exchange code files, coordinate files with ZT20.

Steps:

- ① Connect ZT20 and computer via a data transfer cable.

Microsoft Active sync is required to be installed on the PC to facilitate the data transfer.



ZT20 has to be at power on status while connecting. If MS ActiveSync is not prompted after connection, check if your computer has been set up to prevent it from starting-up.

② Select “Data Exchange Manager”, click “option”→ port settings”, select “USB” for port and “ZT20” for instrument “type”.

The connection may take a short while, before you can see the data of ZT20 displayed.

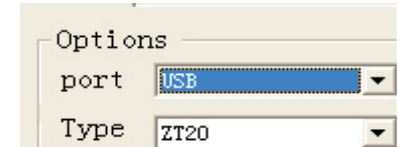

③ Data transfer. Data can be transferred by dragging and dropping it in the desired directory. Select the file on the left window, drag and drop it in one of the directories in the right window. The user will be prompted for the data format that the user wants to save the data in. Vice versa, users can upload data from computer to ZT20.

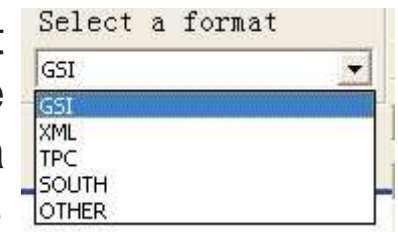

There are five formats that users can chose from. “GSI” is the default format.

- **Onboard software update**

New software version can be uploaded to your instrument. Click “upload file” button, a dialogue pops up as this.

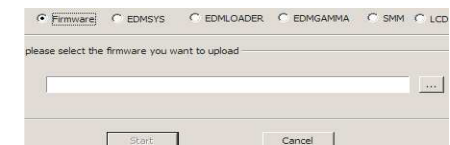

To upload, select firmware with extension name of (.fw). Do not disconnect the cable or removing the battery while uploading is in progress.

The instrument will restart automatically after uploading is completed..

- **Coordinate Editor**

Steps of uploading coordinate file:

- ① Ensure the uploaded coordinate file is in ASCII format and separated by column separators.
- ② Use “Coordinate Editor” to open the ASCII file, then follow through the screen instruction to import the data.
- ③ When data is imported, save the file in GSI format. Then use “Data exchange manager” upload it to the instrument.

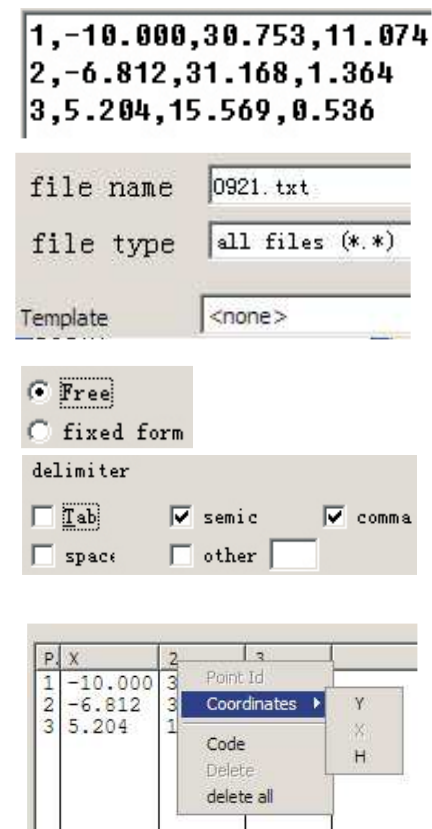

- Format manager
Create and edit format files.
- Code manager
Create and edit format files.



GSI (format) does not support code begins with “0”, the “0” will be ignored automatically.

Power supply

Please use the batteries and chargers provided by GeoMax to ensure the proper performance of the instrument.

GeoMax ZT20 product is powered by chargeable Li-ion battery.

Battery model ZBA 301, Battery capacity 4400mAh, voltage 7.4V.



Chapter 2

Instrument Setup

Contents:

- Container contents
- Operating with the battery
- Level/plummet
- Input mode
- Distance measurements

Container Contents

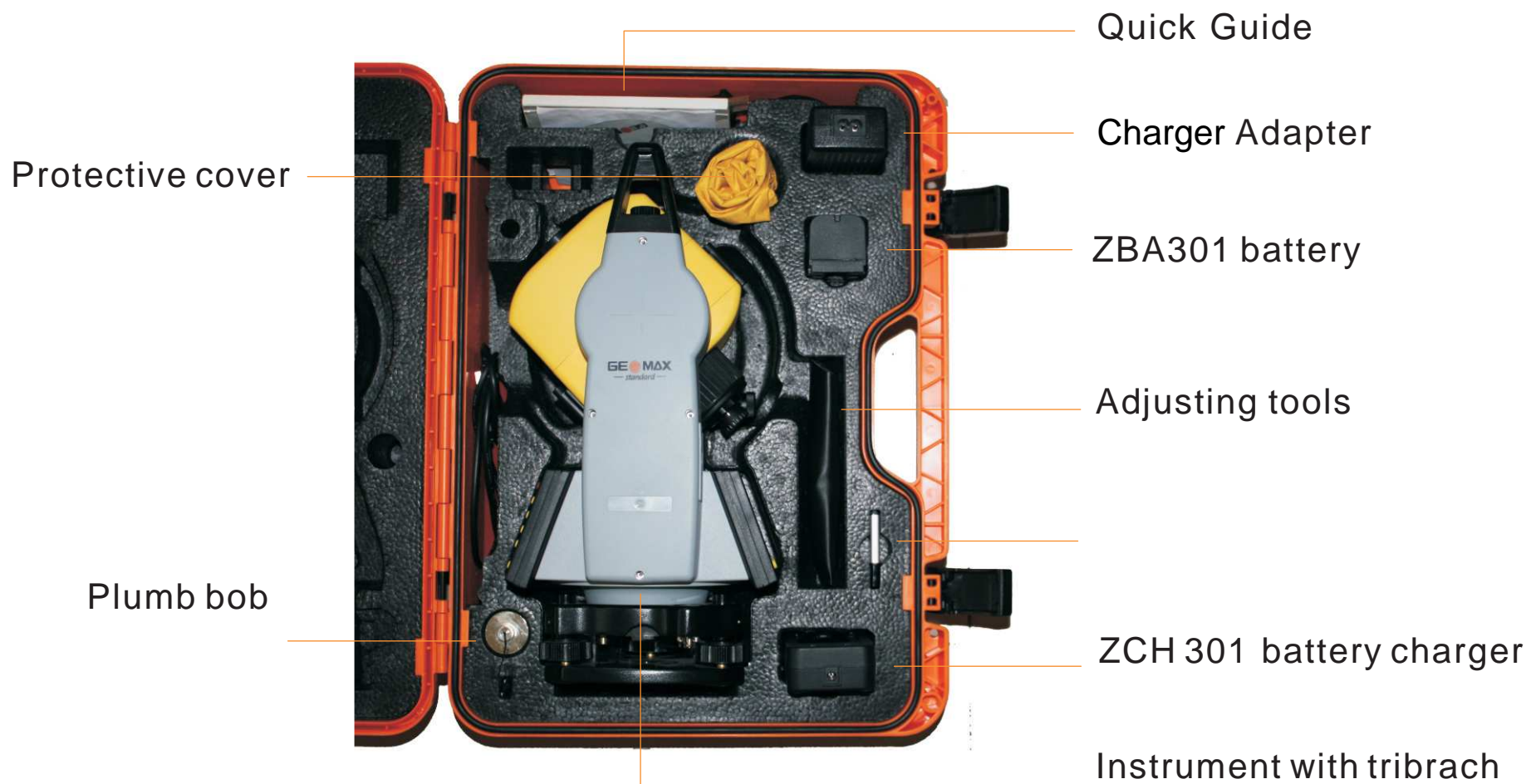

Operating with the battery

Change the battery step by step

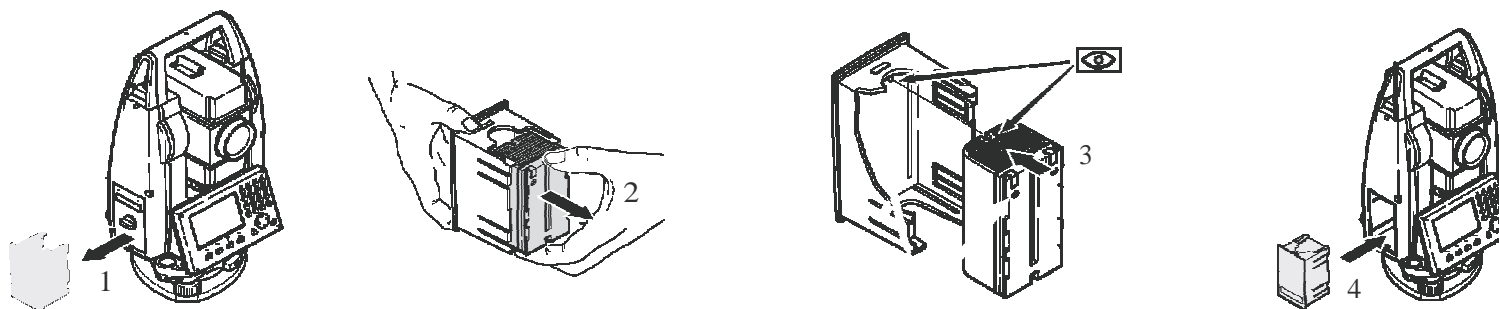

- ① Open the battery compartment and remove the battery holder.
- ② Remove the battery from the battery holder.
- ③ Insert the new battery into the battery holder, ensuring that the contacts are facing outward. The battery should click into position.
- ④ Insert the battery holder back into the battery compartment.

Charging / first-time use

- The battery must be charged prior to using it for the first time because it is delivered with an energy content as low as possible.
- For new batteries or batteries that have been stored for a long time (> three months), it is effectual to make only one charge/discharge cycle.
- The permissible temperature range for charging is between 0°C to +40°C. For optimal charging we recommend charging the batteries at low ambient temperature of +10°C to +20°C.

- It is normal for the battery to become warm during charging. Using the chargers recommended by GeoMax, it is not possible to charge the battery if the temperature is too high.+
- For Li-Ion batteries, a single discharging and charging cycle is sufficient. We recommend carrying out the process when the battery capacity indicated on the charger or on a GeoMax product deviates significantly from the actual battery capacity available.

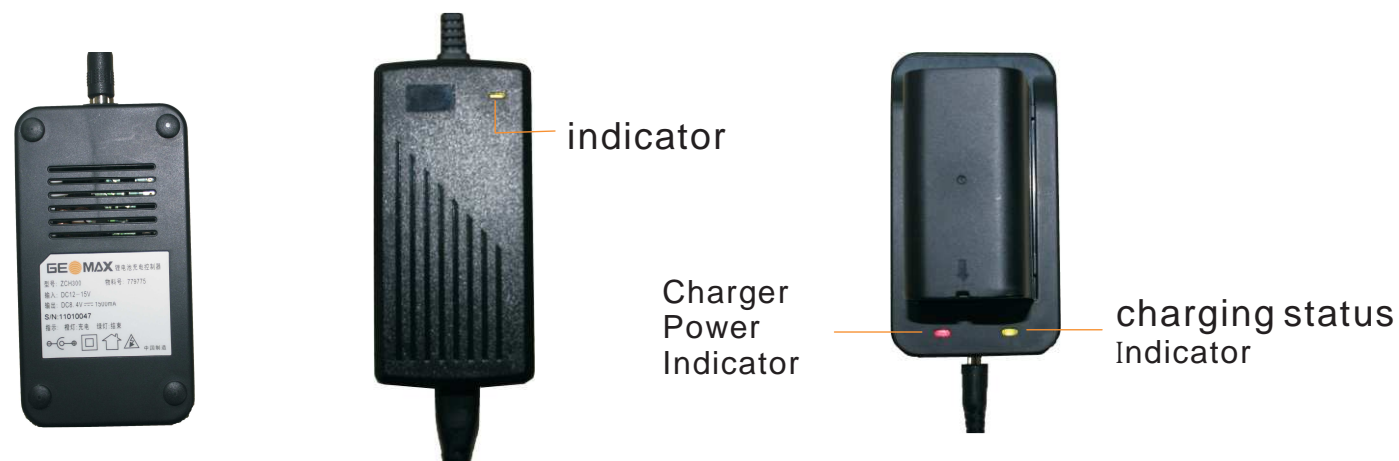

- When connecting to the power source, the indicator on adapter shows green, while the charger power indicator shows red.
- During the charging process, the charging status indicator shows orange, when the battery is fully charged, it shows green.

Operation / discharging

- The batteries can be used at temperatures ranging from -20°C to +50°C.
- Low operating temperatures reduce the capacity that can be drawn; very high operating temperatures reduce the service life of the battery.

Level/Plummet

Setup step-by-step

1. Extend the tripod legs to allow for a comfortable working posture. Position the tripod over the marked ground point, centering it on the point.
2. Fasten the tribrach and instrument onto the tripod.
3. Turn on the instrument, and, if tilt correction is set to 1- or 2- axis, the laser plummet will be activated automatically, and the Level/Plummet screen appears. Otherwise, press FNC from within any application and select Level/Plummet.
4. Move the tripod legs and use the tribrach footscrew to center the plummet over the ground point.
5. Adjust the tripod legs to level the circular level.
6. By using the electronic level, turn the tribrach footscrews to precisely level the instrument. Refer to “Level up with the electronic level step-by-step”.
7. Center the instrument precisely over the ground point by shifting the tribrach on the tripod plate.
8. Repeat steps 6 and 7 until the required accuracy is achieved.

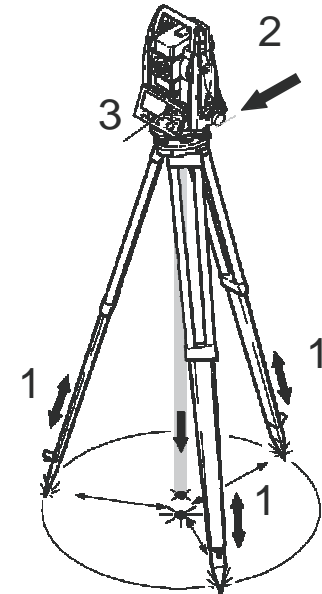

External influences and the surface conditions may require the adjustment of the intensity of the laser plummet. In the Level/Plummet screen, adjust the intensity of the laser plummet using the navigation key. The laser can be adjusted in 25% steps as required.

Level up with the electronic level step-by-step

The electronic level can be used to precisely level up the instrument using the footscrews of the tribrach.

- ① Set the tubular plate bubble parallel to two footscrews.
- ② Turn on the instrument, and if tilt correction is set to 1 or 2 axis, the laser plummet will be activated automatically, and the Level/ Plummet screen appears. Otherwise, press FNC from within any application and select Level/Plummet.
- ③ Centre bubble by turning the two foot screws in equal and opposite directions.
- ④ Turn the instrument through 90° and centre the bubble with the third foot screw.
- ⑤ Repeat steps 3 and 4 until the required accuracy is achieved.

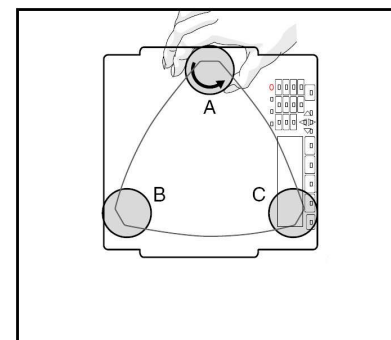
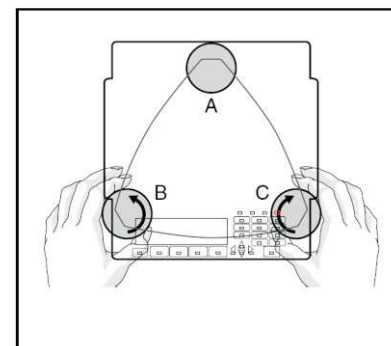

Input mode

- Numerical fields: Contains only numerical values. By pressing the numeric key on the keypad the number will be displayed.
- Alphanumeric fields: Contains numbers and alphabets. By pressing the “alpha-num” key the first character printed on that key will be displayed. By pressing several times you can toggle through the characters. For example: 1->S->T->U->1->S....

Edit fields



ESC Deletes any changes and restores the previous value.



Moves the cursor to the left.



Moves the cursor to the right.



Inserts a character at the cursor position.



Deletes the character at the cursor position.

In edit mode the position of the decimal place cannot be changed.

Special characters

Character	Description
*	Used as wildcards in search fields for point numbers or codes.
+/-	In the alphanumeric character set “+” and “-” are treated as normal alphanumeric characters with no mathematical function.
	“+”/”-” only appear in front of an entry.

Pointsearch

Pointsearch is a function used by applications to find measured or fixed points in the memory storage.

It is possible to limit the point search to a particular job or to search the whole storage. The search procedure always finds fixed points before measured points that fulfill the same search criteria. If several points meet the search criteria, then the results are displayed in order to the entry date. The instrument finds the most recent fixed first.

Direct search

By entering an actual point number, and pressing SEARCH, all points within the selected job and with the corresponding point number are found.

Wildcard search

The wildcard search is indicated by a “*”. The asterisk is a place holder for any following sequence of characters. Wildcards should be used if the point number is not fully known, or to search for a batch of points.

Examples of point searches

-
- | | |
|-----|--|
| * | All points are found |
| A | All points with exactly the point number “A” are found. |
| A* | All points starting with “A” are found, for example, A9, A15, ABC. |
| *1 | All points containing only one “1” are found, for example, 1, A1, AB1. |
| A*1 | All points starting with “A” and containing only one “1” are found. |

Distance Measurements

A laser distancer (EDM) is incorporated into the ZT20 instruments. In all versions, the distance can be determined by using a visible red laser beam which emerges coaxially from the telescope objective. There are two EDM modes:

- Prism measurements
- Non-Prism measurements

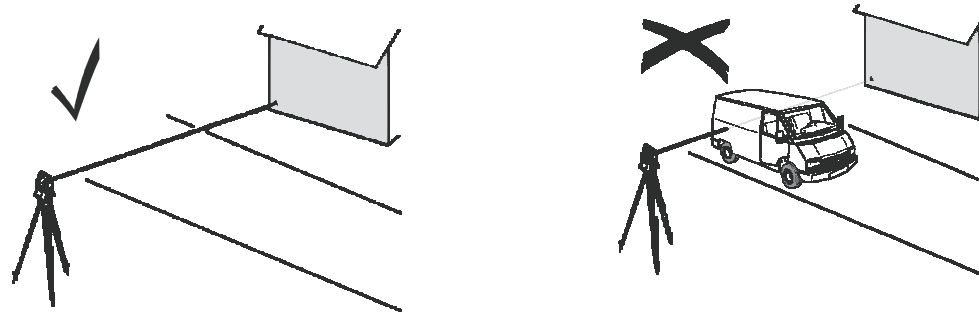

When a distance measurement is triggered, the EDM measures to the object which is in the beam path at that moment. If a temporary obstruction, for example a passing vehicle, heavy rain, fog or snow is between the instrument and the point to be measured, the EDM may measure to the obstruction.



Be sure that the laser beam is not reflected by anything close to the line of sight, for example highly reflective objects. Avoid interrupting the measuring beam while taking Non-Prism measurements or measurements using reflective foils. Do not measure with two instruments to the same target simultaneously.

Prism measurements

Accurate measurements to prisms should be made in Prism-standard mode. Measurements to strongly reflecting targets such as traffic lights in Prism mode without a prism should be avoided. The measured distances may be wrong or inaccurate.

When a distance measurement is triggered, the EDM measures to the object which is in the beam path at that moment. If for example, people, cars, animals, or swaying branches cross the laser beam while a measurement is being taken, a fraction of the laser beam is reflected from these objects and may lead to incorrect distance values.

Measurements to prisms are only critical if an object crosses the measuring beam at a distance of 0 to 30 m and the distance to be measured is more than 300 m.

In practice, because the measuring time is very short, the user can always find a way of avoiding unwanted objects from interfering in the beam path.

Red laser to prism

Prism (>3 km) mode enables distance measurements of over 3 km to standard prisms using the visible red laser beam.

Red laser to reflector foil

The visible red laser beam can also be used to measure to reflective foils. To guarantee the accuracy, the red laser beam must be perpendicular to the reflector foil and it must be well adjusted.

Make sure the additive constant of the selected target (reflector) is input correctly.

 Warning

Due to laser safety regulations and measuring accuracy, using the Long Range Reflectorless EDM is only allowed to prisms that are more than 1000 m (3300 ft) away.

Chapter 3

Operation

Contents:

- Keyboard
- Functions
- Status Icons

Keyboard

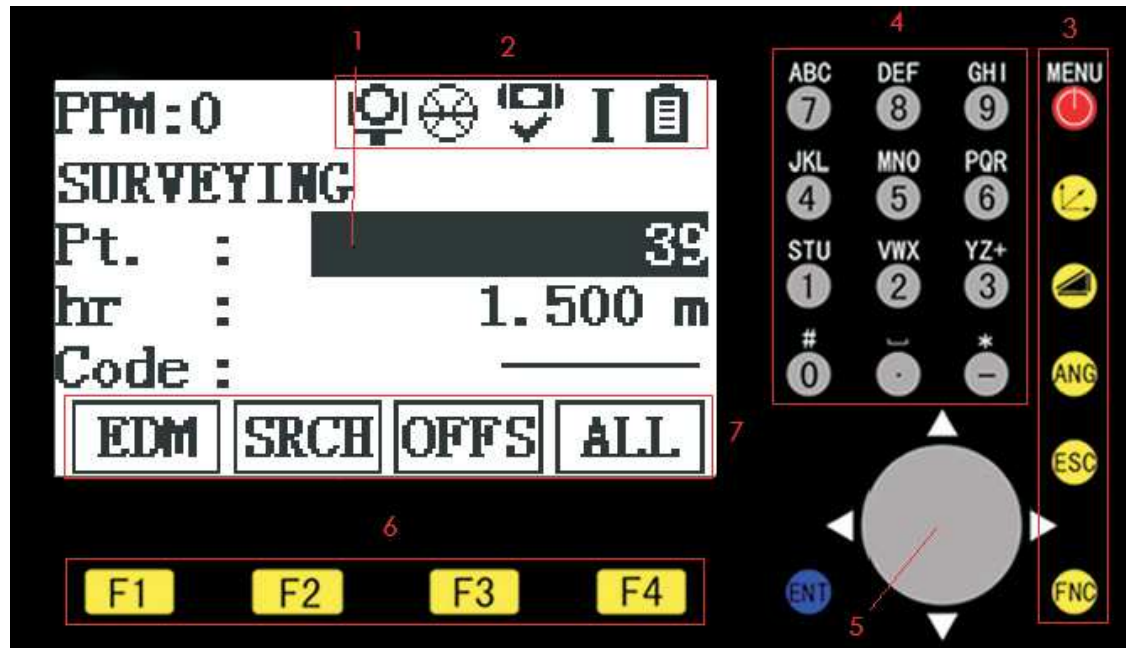

- 1.Focus on screen. Active field
- 2.Status icons
- 3.Fixed function access keys
- 4.Alphanumeric keypad for entry of text and numerical values.
- 5.Navigation key. Controls the focus bar within the screen
- 6.Function keys, F1 to F4
7. Softkeys

Fixed function access keys

MENU key: Access to Applications, Data Manager, Setting & Calibration.

Coordinate key: Access to coordinate measurement screen.

Distance key: Access to distance measurement screen.

ANG key: Access to angle measurement screen.

FNC key: Quick-access to measurement supporting functions.

ESC key: Quits a screen or edit mode without saving changes. Returns to next higher level.

ENT key: Confirms an entry and continues to the next field.

Softkeys

Softkeys are selected using the relevant F1 to F4 function key. This chapter describes the functionality of the common softkeys used by the system. The more specialised softkeys are described where they appear in the application chapters.

Common softkey functions:



Please refer to relevant chapters for further information.

Angle measurement screen

Press ANG key in Quick-survey screen to access.

Page	Key	Function	Description
1	F1	Hz=0	To set horizontal angle to 0
	F2	Lock	To lock horizontal angle
	F3	Hz=?	To set horizontal angle to your input
	F4	P1↓	To display page 2 functions
2	F1	COMP	To view and change compensator settings
	F2	RMEA	To access to angle repeated measurements
	F3	V%	To show grade between instrument and target point
	F4	P2↓	To display page 3 functions
3	F2	R/L	To set horizontal angle to left side angle measurement or right
	F3	ZA	To set the vertical angle to Zenith=0° or Horiz.=0°
	F4	P3↓	To display page 1 functions

Distance measurement screen

Press Distance key in Quick-survey screen to access.

Page	Key	Function	Description
1	F1	P/NP	To toggle between Prism and Non-Prism EDM modes.
	F2	OFFS.	To access Offset function
	F3	MEAS	To start distance and angle measurement.

Page	Key	Function	Description
2	F4	P1↓	To display page 2 functions
	F1	m/ft	To toggle the Distance unit between meter and US-ft
	F2	S/O	To access to Stake out application
	F3	EDM	To view and change EDM settings.
	F4	P2↓	To display page 1 functions

Coordinate measurement screen

Press Coordinate key in Quick-survey screen to access.

Page	Key	Function	Description
1	F1	P/NP	To toggle between Prism and Non-Prism EDM modes.
	F2	OFFS	To access to Offset function
	F3	MEAS	To start coordinate measurement
	F4	P1↓	To display page 2 functions
2	F1	hr	To enter reflector height
	F2	hi	To enter instrument height
	F3	STN.	To enter station coordinates
	F4	P2↓	To display page 3 functions
3	F1	m/ft	To toggle distance unit between meter and US-ft
	F3	EDM	To view and change EDM settings.
	F4	P3↓	To display page 1 functions

Functions

Functions can be accessed by pressing FNC from any measurement screen.

Level/Plummet

Activates the laser plummet and electronic level.

Screen Illumination On /Off

Activates and deactivates the screen illumination light.

Data confirm

Activates and deactivates the data confirm message.

Delete Last Observation

Deletes the last recorded data block. This can be either a measurement block or a code block.

Laserbeam

Activates/deactivates the visible laser beam.

Settings

Adjusts LCD contrast, turn on/off tilt correction and others.

NP/P Toggle

Changes between the two EDM modes.

Compensator

Changes compensator settings.

Status Icons

The icons provide status information related to basic instrument functions.

From left to right of the screen: PPM, Prism type, Compensator, Face 1/2, Battery Level.

PPM: Display atmospheric ppm.

Prism type: Indicates the current prism set. Consists of two icons, the first indicates working status(P/NP/Tape), the second indicates prism type.



Prism-Round



Prism-Mini



Prism-JpMini



Prism-360°



Prism-360° Mini

 P-User. In the mode, prism constant is editable.

 Non-Prism

 NP-User

 Tape

 Tape-user

Compensator Status:

 Compensator is on.

 Compensator is off.

Face one or two

I Face 1

II Face 2

Battery level

 Indicates the level of the remaining battery. It's shown in 25% steps.

Quick-Survey

Contents:

- Angle Measurements
- Distance measurements
- Coordinates measurements

Chapter 4

The Quick-survey is the starting place for accessing all functionality of the instrument. It is the default display screen after the instrument is switched on.

Angle measurement Dialog

Press ANG key to access.

Measure horizontal and vertical angles between points.

- ① Aim the first target point A.
- ② Set Horizontal angle to 0° 0' 0" by pressing F1.
- ③ Press F4 [YES] for confirmation.
- ④ Aim the second target point B, Field "HR" shows the horizontal angle between point B and A. "VA" shows current vertical angle.

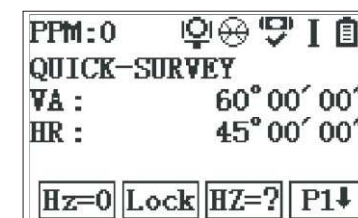
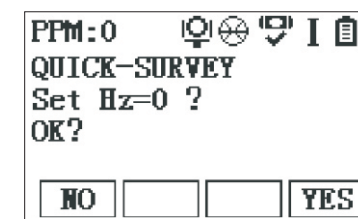

Set HR or HL

Switch to page 3 functions by pressing F4 twice, then you can use F2[R/L] to set the horizontal angle reading to the left (anticlockwise) or to the right (clockwise).

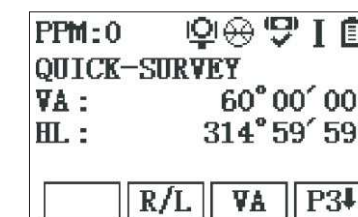

Set horizontal angle

By locking angle values:

- ① Using horizontal drive to set the required angle value.
- ② Press F2[Lock] to hold it.
- ③ Aim target, then press F4[YES] to return to Quick-survey screen.

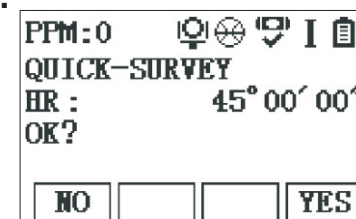

By pressing F1 [NO] to return to previous screen.

By entering angle values manually

- ① Aim target.
- ② Press F3[HZ=?].
- ③ Input your required angle value using the keyboard, then press F4[OK] to accept.

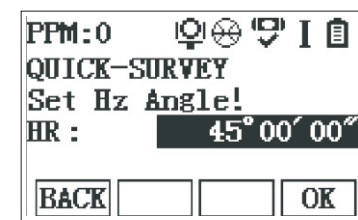

To show the gradient between the instrument and the target point

- ① Switch to page 2 functions by pressing F4.
- ② Press F3[V%] to toggle between degree and grade.

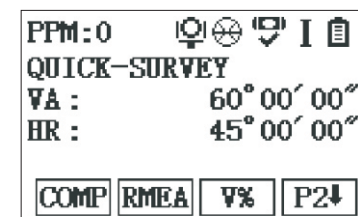

Repeated angle measurements

- ① Switch to page 2 functions by pressing F4.
- ② Press F2[RMEA] then press F4[YES] to enter in.
- ③ Aim target A, then press F2[Hz=0] and F4[YES].
- ④ Aim target B, then press F4[Lock] to complete the first measurement.
- ⑤ Aim target A again, then press F3[Rel.].
- ⑥ Aim target B again, then press F4[Lock] to complete the second measurement.
- ⑦ Repeat ⑤⑥ as many times as you want.



"Ht" is Horizontal angles Total, "Hm" is Horizontal angles mean.



Press ESC to exit.

 The upper limit of Ht is 3600° 00' 00".

 If the current measurement has a difference greater than 10" with Hm. It will prompt "Aim at wrong target, ignore this measurement, press RELEASE".

Setting vertical angle

- ① Switch to page 3 functions by pressing F4 twice.
- ② Press F3[VA] to switch Zenith=0°, Press F3 to change to [ZA]. To press it again, it will switch to horizontal=90°.

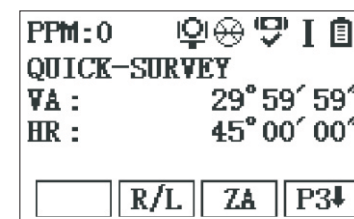

 When vertical angle is set to %, this function will not be available.

Distance measurement Dialog

Press Distance key in Quick-survey screen to access screen 1. Press again to switch to screen 2 .

Screen 1 displays HR, HD, VD. While screen 2 displays VA, HA, SD.

```

PPM:0  [Icons]
QUICK-SURVEY  1/2
HR :          45° 00' 00"
HD :          ____ . ____ m
VD :          ____ . ____ m
[P/NP] [OFFS] [MEAS] [P1↓]
  
```

```

PPM:0  [Icons]
QUICK-SURVEY  2/2
VA :          29° 59' 59"
HR :          45° 00' 00"
SD :          ____ . ____ m
[P/NP] [OFFS] [MEAS] [P1↓]
  
```

Measuring distance:

To measure a distance, aim at the target and press F3[MEAS]. If you want to view SD, switch to screen 2.



Press F1 [P/NP] to toggle between Prism and Non-Prism EDM modes.

In page 2 functions, press F1 [m/ft] to toggle the Distance unit between meter and US-ft. Press F3[EDM] to view and change EDM settings.

Offset measurement

This method may be used in the situation that the required point cannot be measured directly by the Total station. E.g. center of a tree.

Angle offset

- ① Press F2[OFFS] to access.
- ② Press F1[Angle Offset] or numeric key input 1.
- ③ Aim the first target then press F4[OK].
- ④ Press F3[DIST] to get the distance result, then press F4[OK] to go to the next screen.

SELECT METHOD			
F1	Angle Offset	(1)	
F2	Dist. Offset	(2)	
F1	F2		

PPM:0	☺	⊕	☺	I	☺
ANGLE OFFSET					
HR :		45°	00'	00"	
VA :		29°	59'	59"	
First Target!					
BACK	hr			OK	

- ⑤ Aim the second target(the required target), then press F4[OK].
- ⑥ The coordinates of the required point will be displayed on the screen, press F4[OK] to save it to the current job.

```

PPM:0  [Icons]
ANGLE OFFSET
HR :    45° 00' 00"
VA :    29° 59' 59"
Second Target!
[BACK] [hr] [ ] [OK]

```



F2[hr] can be used for setting the height of reflector.

Distance Offset

- ① Press F2 [OFFS] to access.
- ② Press F2[Dist.Offset] or numeric key input 2.
- ③ Input transversal offset(perpendicular to line-of-sight: positive if required point is to the right of the measured point), length offset(positive if required point is further away) and height offset(positive if required point is higher). Press F4[OK].
- ④ Aim target, press F3[DIST]. When the measurement is finished, press F4[OK].

```

PPM:0  [Icons]
DISTANCE OFFSET
TrOff:  1.000 m
Loff :  -1.000 m
HtOff:   0.500 m
[BACK] [hr] [ ] [OK]

```

```

PPM:0  [Icons]
DISTANCE OFFSET
HR :    45° 00' 00"
HD :    8.660 m
VD :    5.000 m
[BACK] [P/NP] [MEAS] [OK]

```

- ⑤ The coordinates of the required point will be displayed on the screen.
Press F4[OK] to save it to the current job.

Coordinates measurement Dialog

Press Coordinate key in Quick-survey screen to access.
Aim target, then press F3[MEAS] to obtain the measurement.

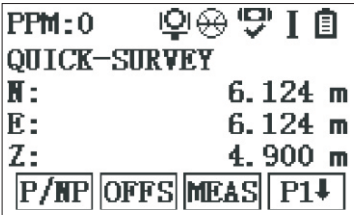

The screenshot shows a dialog box titled 'QUICK-SURVEY'. At the top left, it displays 'PPM:0'. To the right are several icons: a female symbol, a circle with a cross, a shield with a cross, and a document icon. Below the title, the following coordinates are listed: 'N: 6.124 m', 'E: 6.124 m', and 'Z: 4.900 m'. At the bottom, there are four buttons: 'P/HP', 'OFFS', 'MEAS', and 'P1↓'.

PPM:0	♀ ⊕ 🛡️ 📄		
QUICK-SURVEY			
N:	6.124 m		
E:	6.124 m		
Z:	4.900 m		
P/HP	OFFS	MEAS	P1↓

Switch to page 2 functions by pressing F4, you can set the height of reflector, height of instrument and station coordinates.

Chapter 5

Applications

Contents:

- Pre-settings
- Data collection
- Set out
- Missing line Measurement
- Resection
- Area
- Remote elevation

Pre-settings

You need to pre-set JOB, STATION and ORIENTATION before starting an application. For example, Select MENU from Quick-survey screen, and press F1[Data collection].

SURVEY			
F1	Select Job	(1)	
F2	Select Stn	(2)	
F3	Select Ori.	(3)	
F4	GO!	(4)	
F1	F2	F3	F4

Set job

All data is saved in Jobs, like file directories. Jobs contain measurement data of different types, for example measurements, codes, fixed points, or stations. Jobs are individually manageable and can be exported, edited or deleted separately. Press F1[Set job] in pre-settings screen. You can use the navigation key to select an existing job or use F1[NEW] to create a new job.



Once a job is set up, all subsequent recorded data will be stored in this job. If no job was defined or if in Survey and a measurement was recorded, then the system automatically creates a new job and names it "DEFAULT".

Set Station

The coordinates can be entered manually or selected from the database on board the instrument.

- ① Select Set Station in the Pre-settings screen.
- ② Enter the station name.
- ③ Enter the instrument height.

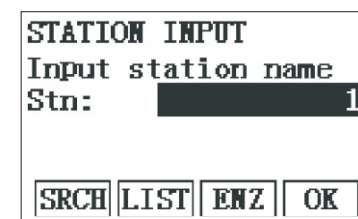

STATION INPUT
Input station name
Stn: [REDACTED] 1
SRCH LIST ENZ OK



You can also use F1[SRCH] or F2[LIST] to select a point from the memory.



You can use F3[ENZ] to create a new point for station.

The station coordinates that are set must include: at least grid coordinates (E, N), and the station height, if required.



If no station was set or if in Quick-survey and a measurement was done, then the last station is set as the current station.

Set orientation

All measurements and coordinate computations are referenced to the orientation of the set station. The orientation can be entered manually or determined from points that are either measured or selected from the memory.

- Manual Orientation: enter a new bearing manually.
- Orientation with Coordinates: calculate and set the orientation using existing coordinates.

Manual Orientation

- ① Select Set Orientation in the Pre-settings screen.
- ② Select Manual Angle in the ORIENTATION screen.
- ③ Input the bearing and then aim at target.
Press F4[YES] to set the orientation and return to the Pre-Settings screen.

MANUAL ANGLE SETTING	
hr :	1.500 m
Brg. :	45° 00' 00"
Aim at target?	
<input type="checkbox"/> NO	<input checked="" type="checkbox"/> HA=0 YES



Press F3[HA=0] to set bearing to 00° 00' 00".

Orientation with Coordinates

The backsight point can be entered manually or selected from the memory.



The station coordinates that are set must include: at least grid coordinates (E, N), and the station height, if required.



If no orientation was set or if in Quick-survey and a measurement was done, then the current horizontal direction is set as the orientation.

- ① Select Set Orientation in the Pre-settings screen.
- ② Select Coordinates in the ORIENTATION screen.
- ③ Enter BS PtID, then press F4[OK].

Enter Target Data			
Enter BS PtID!			
BS ID:			⏏
SRCH	LIST	ENZ	OK

- ④ The computed bearing will be displayed on the screen, sight target point then press F4 [YES].

ORIENT. by COORD.			
Brg. :		45° 00' 00"	
Sight target point!			
NO			YES

Data collection

Data collection is an application used for topographical survey to gather detail field measurements. It is comparable to Quick-survey, but includes pre-settings for the job, station and orientation prior to commencing a survey.

Access:

- ① Select MENU from Quick-survey screen.
- ② Select Data collection from Main Menu.
- ③ Complete application pre-settings.
- ④ Press F4 [GO!] to access to data collection screen.



Use navigation key to select the field you want to input, including PtID, hr or Code. Aim at the target then press F4[All] to measure and record.

F1[EDM]: access to EDM configuration.

F2[SRCH]: find points existed in current job.

F3[OFFS]: access to offset measurement.

Change screen among coordinate, distance and

angle dialogs: Change to coordinate screen

Press coordinate key at data collection screen.

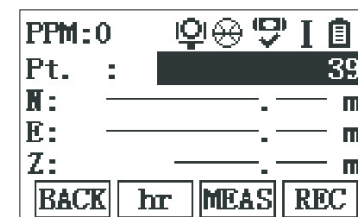

Use F3[MEAS] to obtain coordinates. Use F4[REC] to save it to current job and the PtID increments automatically.



If you press REC without MEAS, it will only save the angle values.

F1[BACK]: back to the previous screen.

F2[hr]: Enter the reflector height.

Change to distance screen

Press distance key at data collection screen. Use F3[MEAS] to get SD, HD and VD and display them on the screen, use F4[REC] to save it to current job and the PtID increments automatically.

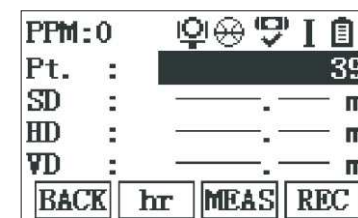

If you press REC without MEAS, it will only save the angle values.

F1[BACK]: back to the previous screen.

F2[hr]: Enter the reflector height.

Change to angle screen

Press angle key at data collection screen. The current angles are shown on screen, use F4[REC] to save it to current job and the PtID increments automatically.

F1 [BACK]: back to the previous screen.

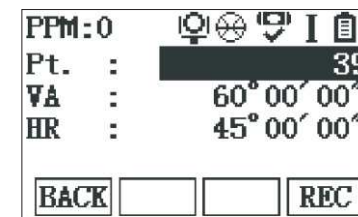

Set out

Set Out is an application used to place marks in the field at predetermined points. These predetermined points are the points to be staked out. The points to be staked may already exist in a job on the instrument, or can be manually entered. The application can continuously display differences, between current position and desired set out position.

Points can be staked using different modes: Polar mode, Orthogonal to station mode and Cartesian mode.

Polar Set Out mode

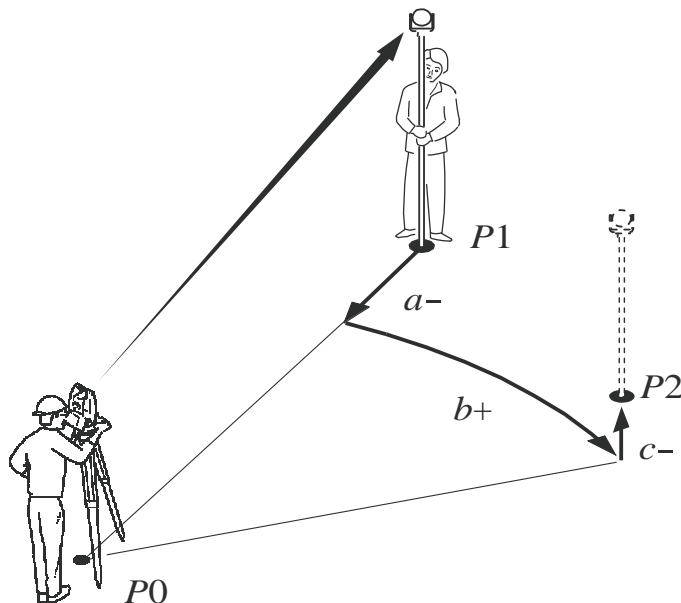

P0 Station

P1 Current position

P2 Point to be set out

a- Longitudinal offset: positive if point to be set out is further away.

b+ Angle offset: positive if point to be set out is to the right of the actual direction.

c+ Height offset

Orthogonal to Station Set Out mode

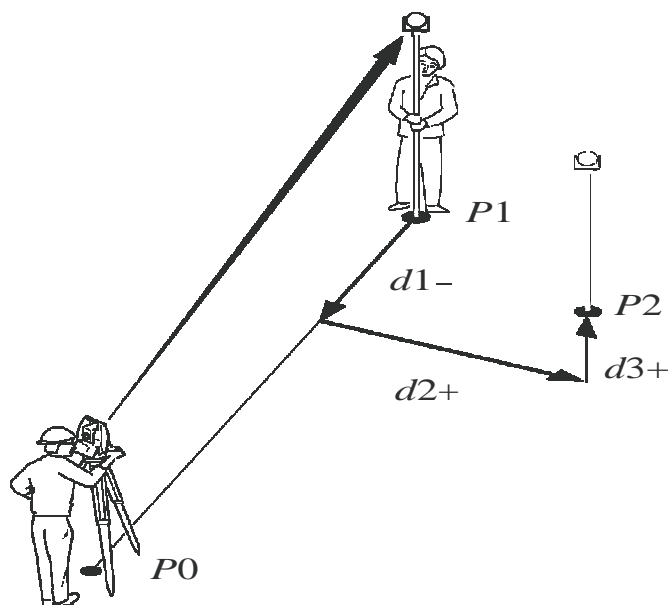

- P0 Station
- P1 Current position
- P2 Point to be set out
- d1- Longitudinal offset: positive if nominal point is further away.
- d3+ Transversal offset, perpendicular to line-of-sight: positive if nominal point is to the right of the measured point.
- d3+ Height offset

Cartesian Set Out mode

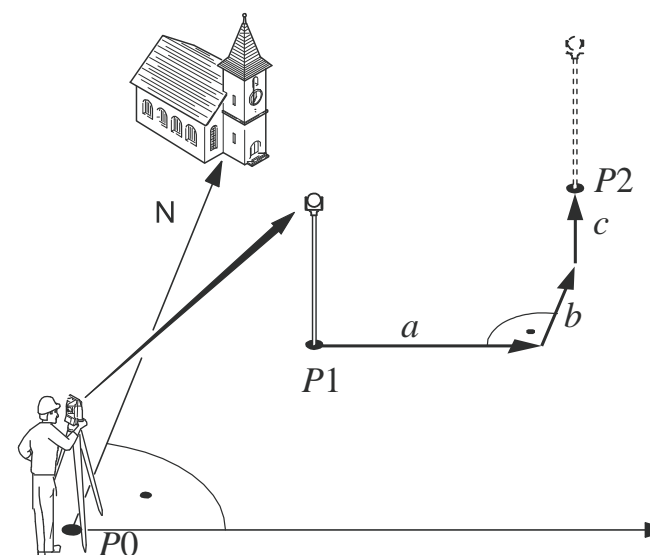

- P0 Station
- P1 Current position
- P2 Point to be set out
- a Easting offset between point to be set out and actual point.
- b Northing offset between point to be set out and actual point.
- c Height offset

Access

- ① Press MENU at Quick-survey screen.
- ② Select Set out from main menu.
- ③ Complete application pre-settings.
- ④ Press F4[Go!] to start.

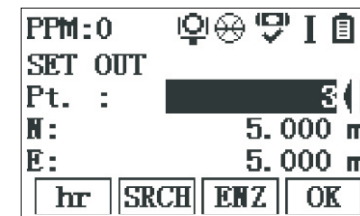

Use navigation key to select the Point you want to set out.

F1[hr]: input the reflector height.

F2[SRCH]: find points existed in the current job.



The point to be set out must include: at least grid coordinates (E, N), and the station height, if required.

Press F4[OK] to enter into the set out screen.

The screen shows the computed HZ and HD.

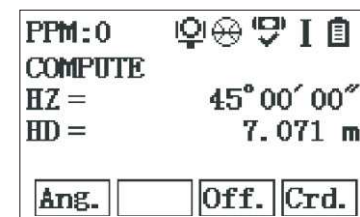

Now, the softkeys have different functions:

F1[Ang.]: enter into polar set out mode.

F3[Off.]: enter into orthogonal to station set out mode.

F4[Crd.]: enter into cartesian set out mode.

Polar set out mode.

Press F1 [Ang.] to enter in. HZ is the computed orientation, dHZ is the angle offset (positive if set out point is to the right of the measured point). Turn the instrument, till dHZ becomes zero, it means the horizontal direction is aligned to the target.

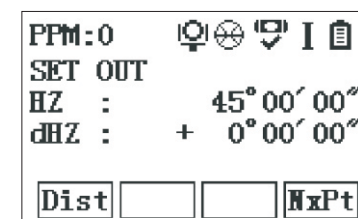

Press F1[DIST] to enter into distance set out.

HD is the computed horizontal distance, d.HD is the horizontal offset (Positive if set out point is further away than the measured point). d.VD is the height offset.



F1[P/NP]: Toggle between Prism and Non-Prism EDM modes.

F2[Off.]: Activate Orthogonal to Station Set Out mode.

F3[MEAS]: Measure distance.

Orthogonal to station set out mode

To access, Press F3[Off.] .

dLen is the longitudinal offset (positive if set out point is further away than the measured point.)

dTra is the longitudinal offset (positive if set out point is further away than the measured point.)

dZ is the height offset (positive if set out point is higher than the measured point.)

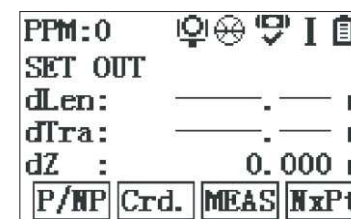

Cartesian set out mode

Press F2[Crđ.] to access the mode.

dN is the northing offset (positive if set out point is further away than the measured point.)

dE is the easting offset (positive if set out point is to the right of the measured point.)

dZ is the height offset (positive if set out point is higher than the measured point.)

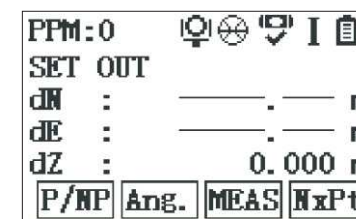



The following are the descriptions used.

Field	Description
dHZ	Angle offset: Positive if set out point is to the right of the measured point.
dHD	Horizontal offset: Positive if set out point is further away than the measured point.
dVD	Height offset: Positive if set out point is higher than the measured point.
dLen	Longitudinal offset: Positive if set out point is further away than the measured point.
dTra	Perpendicular offset: Positive if set out point is to the right of the measured point.
dH	Height offset: Positive if set out point is higher than the measured point.
dN	Northing offset: Positive if set out point is further away than the measured point.
dE	Easting offset: Positive if set out point is to the right of the measured point.
dZ	Height offset: Positive if set out point is higher than the measured point.

Missing Line Measurement

Missing Line Measurement is an application used to compute slope distance, horizontal distance, height difference and azimuth between two target points which are either measured, selected from the memory, or entered using the keypad.

The user can choose between two different methods:

- Polygonal: P1-P2, P2-P3, P3-P4.
- Radial: P1-P2, P1-P3, P1-P4.

Polygonal method

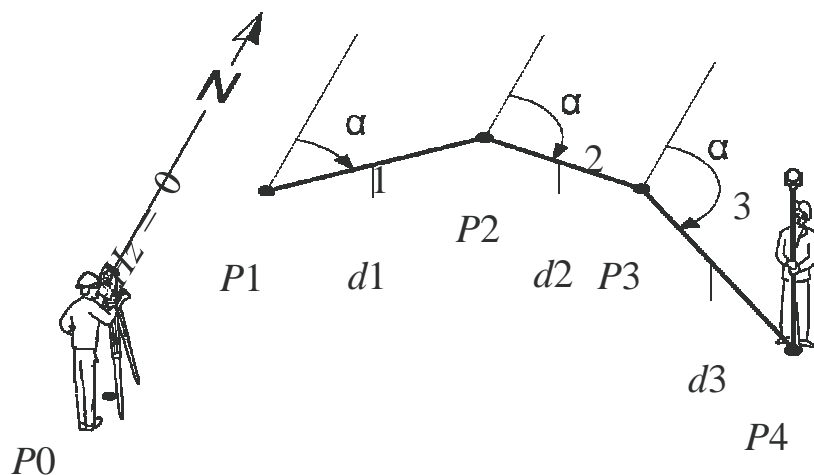

P0	station
P1-P4	target points
d1	distance from P1 to P2
$\alpha 1$	Azimuth from P1 to P2
d2	distance from P2 to P3
$\alpha 2$	Azimuth from P2 to P3
d3	distance from P3 to P4
$\alpha 3$	Azimuth from P3 to P4

Radial method

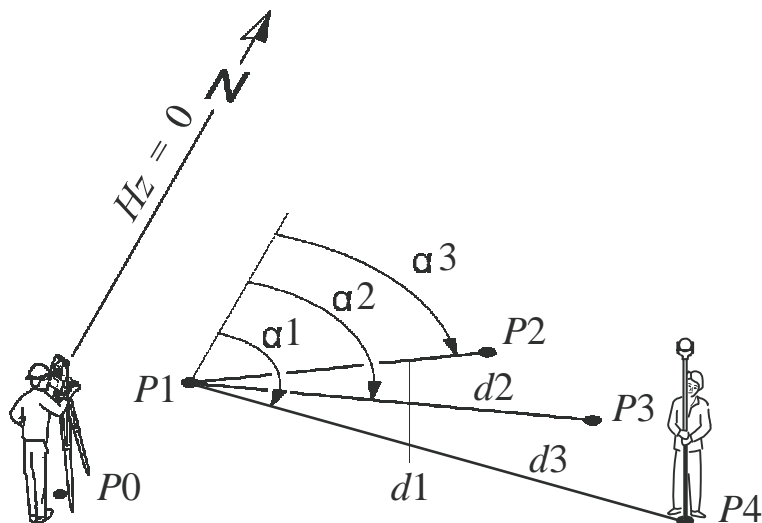

P0	station
P1-P4	target points
d1	distance from P1 to P2
a1	Azimuth from P1 to P2
d2	distance from P1 to P3
a2	Azimuth from P1 to P3
d3	distance from P1 to P4
a3	Azimuth from P1 to P4

To access

- ① Press MENU at Quick-survey screen.
- ② Select F3 [Apps] from main menu.
- ③ Select F1 [MISSING LINE] from APPS.
- ④ Complete application pre-settings.
- ⑤ Press F4 [GO!] to start.

Polygonal method

Select F1 [POLYGON]

This screen requires you to select point 1, the user can aim at the target then measure it by pressing F4[ALL], or select one point from current job by pressing F2[LIST], or enter the point by pressing F3[ENZ].



Repeat point 2 as above.

MLM result

After completing the measurements required, the MLM RESULT screen will appear.

d.HD: Horizontal distance between two points.

dZ: Height difference between point 1 and point 2.

HZ: Azimuth between point 1 and point 2.

F1[NewT]: To calculate an additional line.

Application starts again at point 1.

F2[NewP]: To set point 2 as the starting point of a new line. A new point 2 must be measured.

F4[RADI]: To switch to radial method.

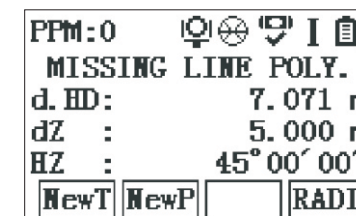
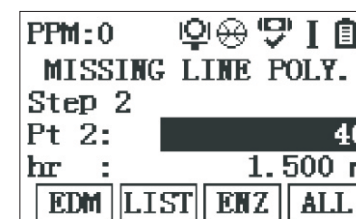

Resection

Resection is an application used to determine the instrument's position from measurements to known points. A minimum of two known points and a maximum of 5, can be used to determine the position.

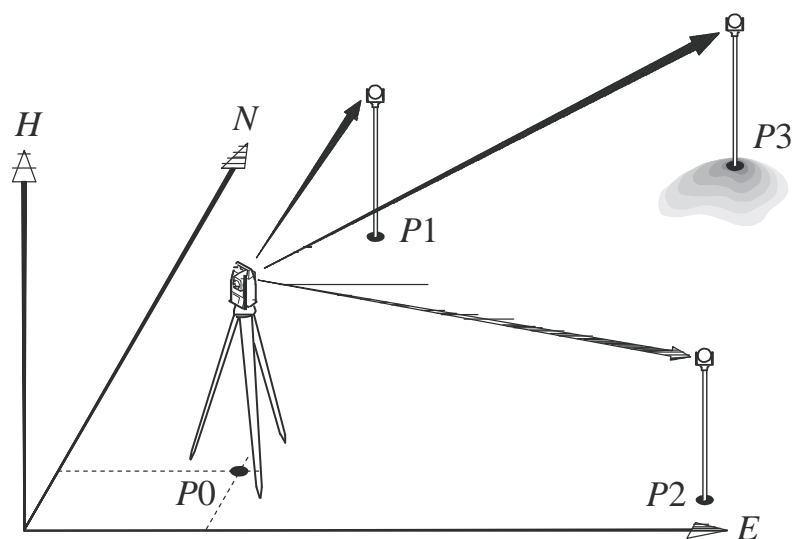

P0 station
P1 known point
P2 known point
P3 known point

Access

- ① Press MENU at Quick-survey screen.
- ② Select F3[Apps] from main menu.
- ③ Select F2[RESECTION] from APPS.
- ④ Complete application pre-settings.

- ⑤ Set accuracy limit:
 - Status: On - to activate a warning message if the calculated standard deviation exceeds the limit.
 - Set the accuracy limits for the Easting, Northing and Height coordinates and the standard deviation angle.
 - Press F4[OK] to save the limits and return to the Pre-settings screen.
- ⑥ Select F4[GO!] to begin the application.

Enter the name of the station and the height of the instrument in the Station data screen and press F1[OK].

Enter the name of the target point or select one point from current job by pressing F2[LIST], or enter the point by pressing F3[ENZ].

On the Sight target screen, press F2[All] to measure the point.

F1[NxPt]: To return to the Enter target data screen to select the next known point.

2/I: Indicates that the second point was measured in face I.

2/I II: Indicates that the second point was measured in faces I and II.

Measuring Information

The following measurement sequences are possible:

- Horizontal direction and vertical-angles only (resection)
- Distance, horizontal direction and vertical-angle.
- Horizontal direction and vertical-angles to some point(s) and horizontal direction and vertical angles plus distance to other point(s).



- Single face I, single face II, or dual face I and II measurements are always possible. No specific point sequence or specific face sequences are required.
- When measuring the same target in both faces, the reflector height may not be changed when observing in the second face. Error checks are made for dual face measurements to ensure the same point is sighted with the other face.
- If a target point is measured several times in the same face, only the last valid measurement is used for the computation.
- For the calculation of the station position, measured target points can be re-measured, included in calculations, or excluded from calculations.
- Target points with 0.000 heights are discarded for height processing. If a target point has a valid height of 0.000 m, use 0.001 m to include it for height processing.

Computation Procedure

The measuring procedure automatically determines the method of evaluation, for example resection or three point resection.

If more than the minimum required measurements are performed, the procedure uses a least-squares adjustment to determine the 3D position and averages orientation and height measurements.

- The original averaged face I and face II measurements are used for the computation process.
- All measurements are treated with the same accuracy, whether these are measured in single or dual face.
- Easting and Northing are determined by the least squares method, which includes standard deviation and improvements for horizontal direction and horizontal distances.
- The final height (Z) is computed from averaged height differences based on the original measurements.
- The horizontal direction is computed with the original averaged face I and face II measurements and the final computed plan position.

Resection Results

Press CALC. from the Sight target point screen after at least two points and a distance have been measured.

This screen displays calculated station coordinates. The final computed results are Easting, Northing and Height coordinates of the present instrument station, including the instrument height.

Standard deviations and residuals for accuracy assessments are provided.

F2[RESID]:To display residuals.

F3[StdDev]: To display the standard deviation of the coordinates and angle.

If the instrument height was set to 0.000 in the setup screen, then the station height refers to the height of the tilting axis.

Target Residuals

The TARGET RESIDUALS screen displays the computed residuals for the horizontal and vertical distances and the horizontal direction.
Residual = Calculated value - Measured value.

Area

Area is an application used to compute online areas to a maximum of 50 points connected by straight lines. The target points have to be measured, selected from the memory, or entered via the keypad in a clockwise direction. The calculated area is projected onto the horizontal plane.

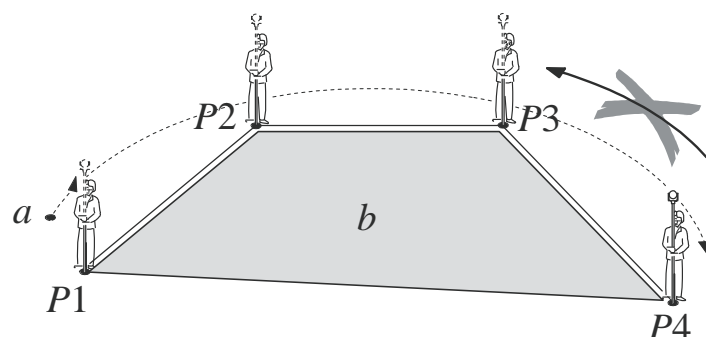

P0 Instrument station

P1 Start point

P2 Target point

P3 Target point

P4 Target point

a Perimeter, polygonal length from start point to the current measured point.

b Calculated area always closed to the start point P1, projected onto the horizontal plane.

Access

- ① Press MENU at Quick-survey screen.
- ② Select Apps from main menu, then select Area.
- ③ Complete application pre-settings, then press F4[GO!].

Enter the target point ID, then press F3[All] to measure and save the point.

Press F4 to change to page 2 functions

Page 1

F1[AdTg]: Enter the name of the target point then select the point from current job. If it doesn't exist, you can input a new one.

F2[1PtB]: To undo measurement or selection of the previous point.

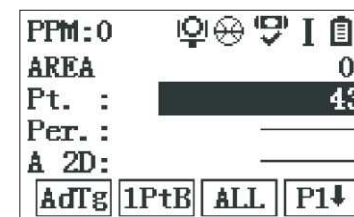

Page 2

F1[EDM]: To view and change EDM settings.

F2[LIST]: To select one point from current job.

F3[CALC]: To display and record area and perimeter results.

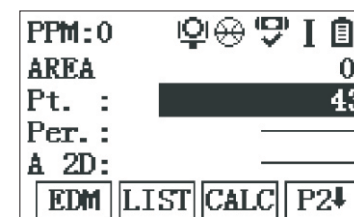

Press F3[CALC] to calculate area and perimeter and proceed to the Area Result screens.

F1[New]: To define a new area.

F4[Adtg]: To add a new target point to the existing area.



Remote Elevation

Remote Elevation is an application used to compute points directly above the base prism without a prism at the target point.

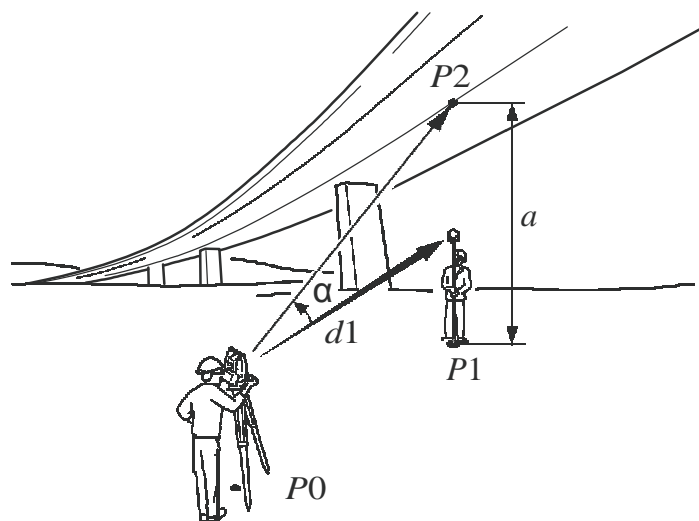

P0 Instrument station
P1 Base point
P2 Remote point
 $d1$ Slope distance
 a Height difference

Access

- ① Press MENU at Quick-survey screen.
- ② Select F3[Apps]->F4[REMOTE ELEVATION].
- ③ Complete application pre-settings then press F4[GO!].

Measure to the base point or press hr=? to determine an unknown reflector height.

When reflector height unknown

Press F4[P1 ↓] to switch to page 2 functions, press F1[hr=?], Enter the point ID then measure the reflector.

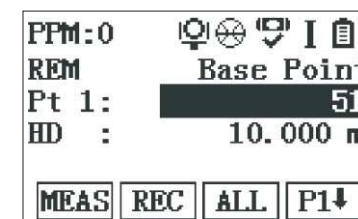

Then turn the telescope and aim at the pole tip, to calculate the reflector height. Press F4[OK] to continue.

Aim the instrument at the inaccessible remote point.

dZ: Calculated difference in Height between the base point and the remote point.

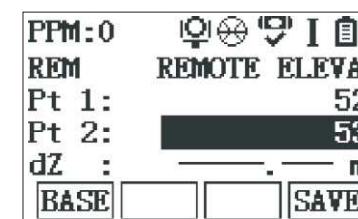

F4[SAVE]: To save the measurement of the remote point.

F1[BASE]: To enter and measure a new base point.

Chapter 6

Data Management

Content:

- Job
- Known Points
- Observations
- Code Library
- Erase Memory
- Memory Information

The Data Manager menu contains all functions for entering, editing, checking and deleting data in the field.

Access

- ① Press MENU at Quick-survey screen.
- ② Select F4[Data manager].

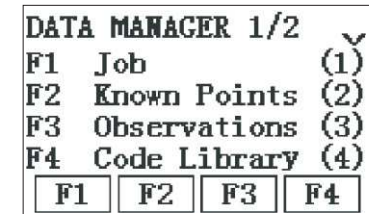

There are six sub-menu, Job, Known Points, Observations, Code Library, Erase Memory, Memory Information.

Job

To view, create and delete jobs. Jobs consist of data of various types, for example, known points, observations or codes. The job definition consists of the job name and user name. The system generates time and date at the time of job creation.

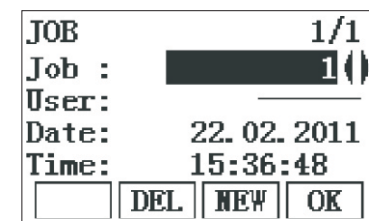

The user can use navigation key to select job.

F2[DEL]: To delete the job.

F3[NEW]: To create a new job, maximum 25 jobs can be created.

F4[OK]: To set the selected job as current job.

Known Points

To view, create, edit and delete known points. Valid fixed points contain at least the point ID and the coordinates E, N or Z.

F1[SRCH]: To search known points.

F2[DEL]: To delete the current point.

F3[NEW]: To create a new point.

F4[EDIT]: To edit the current point.

KNOWN POINT	
Pt. :	2 ()
N:	0.000 m
E:	0.000 m
Z:	0.000 m
[SRCH] [DEL] [NEW] [EDIT]	

Observations

To view and delete observation data. Observation data available in the internal memory can be searched for via a specific point search, or by viewing all points

F3[Point search]: To search observation data.

F4[Shows all Obs]:To show all observations.

```

OBSERVATION
Job:      [REDACTED] 1 (|)
Stn:     [REDACTED] *
F3 Point search
F4 Shows all Obs
[ ] [ ] [F3] [F4]
  
```

Code Library

To view, create, edit and delete codes. To each code a description and a maximum of 8 attributes with up to 16 characters each can be assigned.

F1[NEW]: To create a new code.

F2[DEL]: To delete the current code.

```

CODING 1/3
SRCH : [REDACTED] *
Code : [REDACTED] (|)
REM  :
[NEW] [DEL] [ ] [P↓]
  
```

Erase Memory

Delete individual jobs, known points and observations of a specific job or all jobs in the memory.

Toggle to page 2 in data management, then select F1[Erase Memory].

F1[DEL]: To delete the current selection.

F4[BACK]: To return to the previous screen.

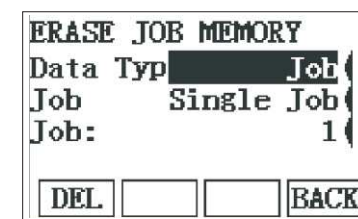

Deleting the memory cannot be undone. After confirming the message all data is permanently deleted.

Memory Information

Displays job specific memory information such as the number of stored stations and known points within a job, the number of recorded data blocks, for example measured points, and the memory space occupied.

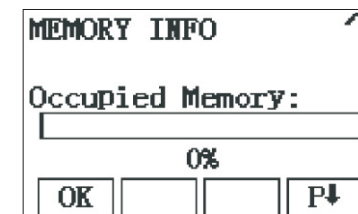
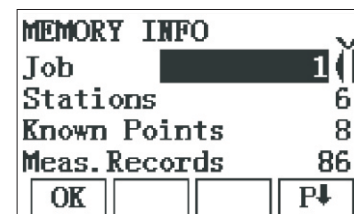

Configuration

Contents:

- General Configuration
- EDM Configuration
- System information

Chapter 7

Access

- ① Press MENU at Quick-survey screen.
- ② Switch to page 2 screen by using the scroll down navigational key, then press F1[Setting].

F1 [General]: To select the instrument settings to suit the user's requirements and habits.

F2 [EDM]: To view and change EDM settings.

F3 [System Info.]: To view system information, edit date and time.

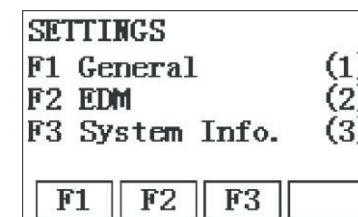

General settings

Press F1[General] to access.

Press [P↓] to scroll through the screens of available settings.

F1[DEFL]: To reset the settings to the default settings.

F3[OK]: To save the current settings.

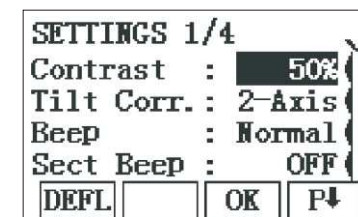

Contrast:

0% to 100%: Sets the display contrast in 10% steps.

Tilt Corr.

1-axis: Vertical angles refer to the plummet line.

2-axis: Vertical angles refer to the plummet line and the horizontal directions are corrected by the standing axis tilt.

Off: Tilting compensation deactivated.



If the instrument is used on an unstable base, for example a vibrating platform or ship, the compensator should be deactivated. This avoids the compensator from drifting out of its measuring range and interrupting the measuring process.

Beep

The beep is an acoustic signal after each key stroke.

Normal: beep is activated.

Off: beep is deactivated.

Sect Beep

Off: Sector Beep is deactivated.

On: Sector Beep sounds at right angles (0° , 90° , 180° , 270° or 0, 100, 200, 300 gon).

AngUnit

Sets the units shown for all angular fields.

dec. de	Degree decimal. Possible angle values: 0° to 359.999°
mil	Mil. Possible angle values: 0 to 6399.99mil.
° ' "	Degree sexagesimal. Possible angle values: 0° to 359° 59'59''
gon	Gon. Possible angle values: 0 gon to 399.999



The setting of the angle units can be changed at any time. The actual displayed values are converted according to the selected unit.

MinRead

Sets the number of decimal places shown for all angular fields. This is for data display and does not apply to data export or storage.

For Angle Unit ° ' " : (0° 00' 01" / 0° 00' 05" / 0° 00' 10").
 Dec.deg: (0.0001 / 0.0005 / 0.001).
 Gon: (0.0001 / 0.0005 / 0.001).
 Mil: (0.01 / 0.05 / 0.1).

DisUnit

Sets the units shown for all distance and coordinate related fields.

Meter	Meters [m].		
US-ft	US feet [ft].		
INT-ft	International feet [fi].	ft-in/16	US feet-inch-1/16 inch [ft].

Disp ill.

Sets the screen illumination on or off.

HA Corr.

On: Horizontal corrections are activated. For normal operation the horizontal correction should remain active. Each measured horizontal angle will be corrected, depending on the vertical angle.

Off: Horizontal corrections are deactivated.

HA Incr.

Right: Set horizontal angle to clockwise direction measurement.

Left: Set horizontal angle to counter-clockwise direction measurement. Counter-clockwise directions are displayed but are saved as clockwise directions.

VA Setting:

Zenith: Zenith=0° ; Horizon=90° .

Horiz: Zenith=90° ; Horizon=0° . Vertical angles are positive above the horizon and negative below it.

Slope %: Vertical angles are expressed in % with positive above the horizon and negative below it.

Auto-OFF:

Enable: The instrument switches off after 15 minutes without any activity , for example no key pressed or vertical and horizontal angle deviation is $\leq 1' 43''$.

Disable: Automatic switch-off is deactivated.

Temp. Unit

Sets the units shown for all temperature fields.

°C: Degree Celsius. °F: Degree Fahrenheit.

Press.Unit

Sets the units shown for all pressure fields.

hPa: Hecto Pascal. mbar: Millibar.

mmHg: Millimeter mercury. inHg: Inch mercury.

Data Conf.

On: Screen prompting data confirmation after pressing [ALL].

Off: Deactivate data confirmation

StartUp DP(Display)

Sets the display start up screen at power on.

Angle: Startup with angle measuring screen. Dist: Startup with distance measuring screen.

EDM Settings

The settings on this screen define the active EDM, Electronic Distance Measurement. Different settings for measurements are available with Non-Prism (NP) and Prism (P) EDM modes.

Access

Select EDM from the Setting menu.

Using the navigation key to change settings, and software key to access to corresponding functions.

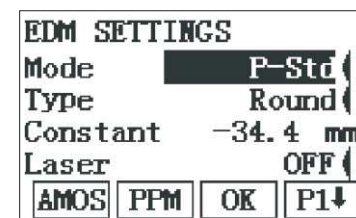

AMOS: This screen enables the entry of atmospheric parameters. Distance measurement is influenced directly by the atmospheric conditions of the air in which the measurements are taken. In order to take these influences into consideration distance measurements are corrected using atmospheric correction parameters.

The refraction correction is taken into account in the calculation of the height differences and the horizontal distance. Refer to "Scale Correction" for the application of the values entered in this screen.



When PPM=0 is selected, the GeoMax standard atmosphere of 1013.25 mbar, 12° C, and 60% relative humidity will be applied.

PPM : This screen enables the entry of individual scaling factors. Coordinates and distance measurements are corrected with the PPM parameter. Refer to "Scale Correction" for the application of the values entered in this screen.

SCAL: This screen enables entry of the scale of projection. Coordinates are corrected with the PPM parameter.



SIGN: This screen tests the EDM signal strength (reflection strength) in steps of 1%. Enables optimal aiming at distant, barely visible targets. A percentage bar and a beeping sound, indicate the reflection strength. The faster the beep the stronger the reflection.

FREQ: To view the EDM frequency.

DEFL: To reset the fields to the default standard settings.

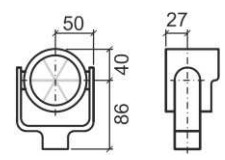
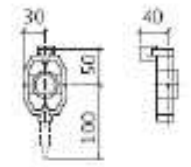
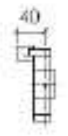
Field	Description	
EDM mode	P-Std	Standard mode for high precision measurements with prisms.
	P-Quick	Quick measuring mode with prisms, with higher measuring speed and reduced accuracy.
	P-Cont	For continuous distance measurements to prisms
	NP-Std	For distance measurements without prism
	NP-Cont	For continuous distance measurements without prism

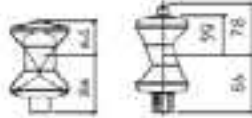
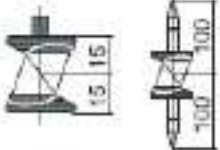
Field	Description		
	NP-Long	For long range distance measurements to prism.	
	Foil	For distance measurements using Retro reflective targets.	
Constant	This field displays the GeoMax prism constant for the selected Prism Type. Where Prism Type: is “Custom” this field becomes editable to set a user defined constant. Input can only be made in mm. Limit value: -999.9 mm to +999.9 mm.		
Laser	Off	Visible laser beam is deactivated.	
	On	Visible laser beam for visualising the target point is activated.	
Prism Type	Round	Constant -34.4mm	
	Mini	Constant -16.9mm	
	MiniJP	Constant 0.0mm	

Field	Description	
360°	Constant -11.3mm	
360°Mini	Constant -4.4mm	
Foil	Constant 0.0mm	
Custom	Constants can be entered by user.	

System information

The System information screens display instrument, system and firmware information, as well as settings for the date and time.

Access

Select F3[System Info.] from settings.

This screen displays instrument type, S/N and current time.

F1[SW]: To display details of the firmware package installed on the instrument.

F2[DATE]: To change the date and format.

F3[TIME]: To change the time.

F4[BACK]: To return to settings screen.

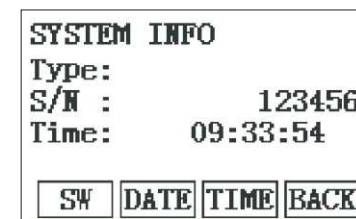

Field	Description
FW ver.	Displays the firmware version number installed on the instrument.
Build	Displays the build number of the firmware.
EDM-Firm	Displays the version number of the EDM firmware.
Software-info	Displays a list of the applications available on the instrument.

Chapter 8

Calibration

Contents:

- Overview
- Preparation
- Program calibration
- Inspecting Laser Plummet

Overview

GeoMax instruments are manufactured, assembled and adjusted to a high quality. Quick temperature changes, shock or stress can cause deviations and decrease the instrument accuracy. It is therefore recommended to check and adjust the instrument from time to time. This can be done in the field by running through specific measurement procedures. The procedures are guided and have to be followed carefully and precisely as described in the following chapters. Some other instrument errors and mechanical parts can be adjusted mechanically.

The following instrument errors can be checked and adjusted electronically:

- Horizontal collimation error, also called line-of-sight error.
- Vertical index error, and simultaneously the electronic level.

For determining these errors, it is necessary to measure in both faces, but the procedure can be started in any face.



During the manufacturing process, the instrument errors are carefully determined and set to zero. As mentioned, these errors can change and it is highly recommended to determine them again in the following situations:

- Before the instrument is used for the first time.
- Before every high precision survey.



- After rough or long periods of transportation.
- After long periods of work or storage.
- If the temperature difference between current environment and the temperature at the last calibration is more than 10°C (18°F).

Preparation

Before determining the instrument errors, level-up the instrument using the electronic level. The Level/Plummet is the first screen to appear after turning on the instrument.

The tribrach, the tripod and the ground should be very stable and secure from vibrations or other disturbances.



The instrument should be protected from direct sunlight in order to avoid uneven thermal expansion.

Before starting to work, the instrument has to become acclimatised to the ambient temperature. Approximately two minutes per °C of temperature difference from storage to working environment, but at least 15 min, should be taken into account.

Program Calibration

Access

- ① Press MENU button at Quick-survey screen.
- ② Switch to page 2, then select F2[Calibration].

CALIBRATION			
F1	HA-Collimatn	(1)	
F2	Vert. Index	(2)	
F3	View Calib.	(3)	
F1	F2	F3	

Line-of-Sight error

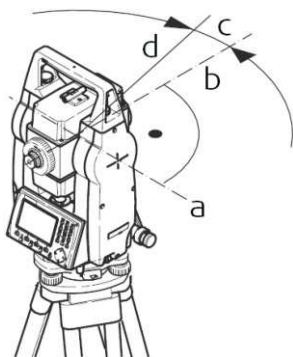

- a Tilting axis
- b Line perpendicular to tilting axis
- d Line-of-sight
- c Horizontal collimation, or line-of-sight, error

The line-of-sight error, or horizontal collimation error is the deviation from the perpendicular between the tilting axis and the line of sight. The effect of the line-of-sight error to the horizontal direction increases with the vertical angle.

Vertical Index Error

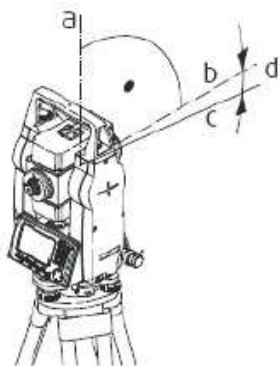

- a Mechanical vertical axis of the instrument, also called standing axis
- b Axis perpendicular to the vertical axis. True 90°
- c Vertical angle is reading 90°
- d Vertical index error

The vertical circle should read exactly 90° (100 gon) when the line of sight is horizontal. Any deviation from this figure is termed vertical index error. This is a constant error that affects all vertical angle readings.

Steps



The procedures and conditions required to correct line-of-sight and vertical index errors are the same, therefore the procedure will only be described once.

- ① Level the instrument with the leveling bubble and electronic level.
- ② Aim at a point approximately 100 m from the instrument which is within 5° of the horizontal.

HA-COLLIMATION			
Step 1			
VA:			$0^\circ 00' 00''$
HA:			$0^\circ 00' 00''$
<input type="text"/>	<input type="text"/>	<input type="text"/>	OK

- ③ Press OK to measure to the target point.
- ④ Change face and aim at the target point again.
- ⑤ The new calculated values are displayed, press OK to save the new adjustment data or press ESC to exit without saving the new adjustment data.

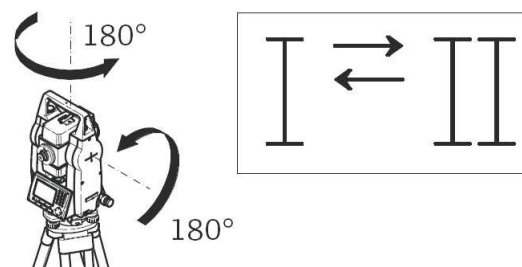
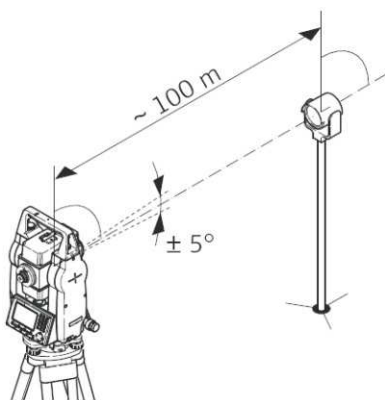
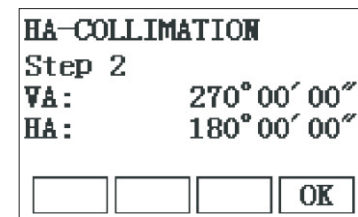

The following are important messages or warnings that may appear.

Messages	Description
VA-angle not suitable for adjustment!	The vertical angle deviates from the required horizontal / line-of-sight, or in face II the vertical angle deviates by more than 5° from the target point. Aim at the target point with an accuracy of min. 5°. Confirmation of the message required.

Messages	Description
Results out of tolerance. Previous values retained!	Computed values out of tolerance. The previous values are retained and measurements should be repeated. Confirmation of the message required.
HA-angle not suitable for adjustment!	Horizontal angle in face II deviates by more than 5° from the target point. Aim on the target point with an accuracy of min. 5°. Confirmation of the message required.
Measurement Error. Try again.	Measurement error appears when, for example, there is an unstable set up. Repeat the process. Confirmation of the message required.
Time limit exceeded ! Please repeat adjustment!	Time difference between measurements for results storage exceeds 15 minutes. Repeat the process. Confirmation of the message required.

Inspecting the Laser Plummet of the Instrument

The laser plummet is integrated into the vertical axis of the instrument. Under normal conditions of use, the laser plummet does not need adjusting. If an adjustment is necessary due to external influences, the instrument has to be returned to a GeoMax service department.

Inspect the laser plummet step-by-step

- ① Set up the instrument on the tripod approximately 1.5 m above the ground and level up.
- ② To activate the laser plummet, turn on the instrument, and, if tilt correction is set to 1- or 2-axis, the laser plummet will be activated automatically, and the Level/Plummet screen appears. Otherwise, press FNC from within any application and select Level/Plummet.



Inspection of the laser plummet should be carried out on a bright, smooth and horizontal surface, such as a sheet of paper.

- ③ Mark the center of the red laser dot on the ground.
- ④ Turn the instrument slowly through 360°, carefully observing the movement of the red laser dot.



The maximum diameter of the circular movement described by the center of the laser dot should not exceed 3 mm at a height of 1.5 m.

- ⑤ If the center of the laser dot makes a clearly circular movement, or moves more than 3 mm away from the point which was first marked, an adjustment may be required. Call your nearest GeoMax service department. Depending on brightness and surface type, the size of the laser dot can vary. At a height of 1.5 m an average diameter of 2.5 mm is estimated.

Chapter 9

Care and Transport

Contents:

- Transport
- Storage
- Cleaning and drying

Transport

Transport in the field

When transporting the equipment in the field, always make sure that you

- either carry the product in its original transport container,
- or carry the tripod with its legs splayed across your shoulder, keeping the attached product upright.



Transport in a road vehicle

Never carry the product loose in a road vehicle, as it can be affected by shock and vibration. Always carry the product in its transport container and secure it.

Shipping

When transporting the product by rail, air or sea, always use the complete original GeoMax packaging, transport container and cardboard box, or its equivalent, to protect against shock and vibration.

Shipping, transport of batteries

When transporting or shipping batteries, the person in charge of the product must ensure that the applicable national and international rules and regulations are observed. Before transportation or shipping, contact your local passenger or freight transport company.

Storage

Product

Adhere to the temperature limits when storing the equipment, particularly in summer if the equipment is inside a vehicle. Refer to "11 Technical Data" for information about temperature limits.

Field adjustment

After long periods of storage inspect the field adjustment parameters given in this user manual before using the product.

Li-Ion batteries

- Refer to "Technical Data" for information about storage temperature range.
- At the recommended storage temperature range, batteries containing a 10% to 50% charge can be stored for up to one year. After this storage period the batteries must be recharged.
- Remove batteries from the product and the charger before storing.
- After storage recharge batteries before using.

- Protect batteries from damp and wetness. Wet or damp batteries must be dried before storing or use.
- A storage temperature range of -20°C to $+30^{\circ}\text{C}$ / -4°F to 86°F in a dry environment is recommended to minimise self-discharging of the battery.

Cleaning and Drying

Product and Accessories

- Blow the dust off lenses and prisms.
- Never touch the glass with your fingers.
- Use only a clean, soft, lint-free cloth for cleaning. If necessary, moisten the cloth with water or pure alcohol. Do not use other liquids; these may damage the polymer components.

For charger

Use only a clean, soft, lint-free cloth for cleaning.

Fogging of prisms

Prisms that are cooler than the ambient temperature tend to fog. It is not enough simply to wipe them. Keep them for some time inside your jacket or in the vehicle to allow them to adjust to the ambient temperature.

Damp products

Dry the product, the transport container, the foam inserts and the accessories at a temperature not greater than 40°C /104°F and clean them. Do not repack until everything is completely dry. Always close the transport container when using in the field

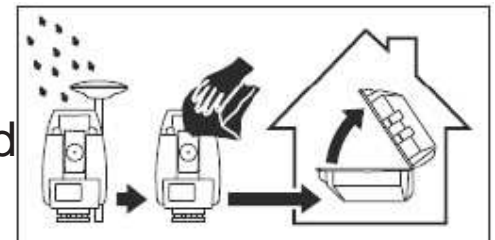

Cables and plugs

Keep plugs clean and dry. Blow away any dirt lodged in the plugs of the connecting cables.

Safety Directions

Contents:

- Intended Use
- Responsibilities
- Hazards of Use
- Laser Classification
- Electromagnetic Compatibility EMC

The following directions enable the person responsible for the product, and the person who actually uses the equipment, to anticipate and avoid operational hazards. The person responsible for the product must ensure that all users understand these directions and adhere to them.

Intended Use

Permitted use

- Measuring horizontal and vertical angles.
- Measuring distances.
- Recording measurements.
- Visualizing the aiming direction and vertical axis.
- Data communication with external appliances.
- Computing by means of software.

Adverse use

- Use of the product without instruction.
- Use outside of the intended limits.
- Disabling safety systems.
- Removal of hazard notices.
- Opening the product using tools, for example screwdriver, unless this is specifically permitted for certain functions.

- Modification or conversion of the product.
- Use after misappropriation.
- Use of products with obviously recognisable damages or defects.
- Use with accessories from other manufacturers without the prior explicit approval of GeoMax.
- Aiming directly into the sun.
- Inadequate safeguards at the working site, for example when measuring on roads.
- Deliberate dazzling of third parties.
- Controlling of machines, moving objects or similar monitoring application without additional control- and safety installations.



Warning - Adverse use can lead to injury, malfunction and damage. It is the task of the person responsible for the equipment to inform the user about hazards and how to counteract them. The product is not to be operated until the user has been instructed on how to work with it.

Limits of Use

Environment

Suitable for use in an atmosphere appropriate for permanent human habitation:
not suitable for use in aggressive or explosive environments.



Danger - Local safety authorities and safety experts must be contacted before working in hazardous areas, or close to electrical installations or similar situations by the person in charge of the product.

Responsibilities

Manufacturer of the product

GeoMax AG, CH-9443 Widnau, hereinafter referred to as GeoMax, is responsible for supplying the product, including the user manual and original accessories, in a safe condition.

Manufacturers of non GeoMax accessories

The manufacturers of non GeoMax accessories for the product are responsible for developing, implementing and communicating safety concepts for their products, and are also responsible for the effectiveness of those safety concepts in combination with the GeoMax product.

Person in charge of the product

The person in charge of the product has the following duties:

- To understand the safety instructions on the product and the instructions in the user manual.
- To be familiar with local regulations relating to safety and accident prevention.
- To inform GeoMax immediately if the product and the application becomes unsafe.

- To ensure that the national laws, regulations and conditions for the operation of radio transmitters are respected.

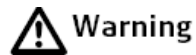

The person responsible for the product must ensure that it is used in accordance with the instructions. This person is also accountable for the training and the deployment of personnel who use the product and for the safety of the equipment in use.

Hazards of Use



Warning - The absence of instruction, or the inadequate imparting of instruction, can lead to incorrect or adverse use, and can cause accidents with far-reaching human, material, financial and environmental consequences.

Precautions: All users must follow the safety directions given by the manufacturer and the directions of the person responsible for the product.



Caution - Watch out for erroneous measurement results if the product has been dropped or has been misused, modified, stored for long periods or transported.

Precautions: Periodically carry out test measurements and perform the field adjustments indicated in the user manual, particularly after the product has been subjected to abnormal use and before and after important measurements.



Danger - Because of the risk of electrocution, it is dangerous to use poles and

extensions in the vicinity of electrical installations such as power cables or electrical railways.

Precautions: Keep at a safe distance from electrical installations. If it is essential to work in this environment, first contact the safety authorities responsible for the electrical installations and follow their instructions.



 **Warning** - If the product is used with accessories, for example masts, staffs, poles, you may increase the risk of being struck by lightning.

Precautions: Do not use the product in a thunderstorm.

 **Caution**- Be careful when pointing the product towards the sun, because the telescope functions as a magnifying glass and can injure your eyes and/or cause damage inside the product.

Precautions: Do not point the product directly at the sun.

 **Warning** - During dynamic applications, for example setout procedures there is a danger of accidents occurring if the user does not pay attention to the environmental conditions around, for example obstacles, excavations or traffic.

Precautions: The person responsible for the product must make all users fully aware of the existing dangers.

 **Warning** - Inadequate securing of the working site can lead to dangerous situations, for example in traffic, on building sites, and at industrial installations.

Precautions: Always ensure that the working site is adequately secured. Adhere to the regulations governing safety and accident prevention and road traffic.

 **Warning** - If computers intended for use indoors are used in the field there is a danger of electric shock.

Precautions: Adhere to the instructions given by the computer manufacturer regarding field use with GeoMax products.

 **Caution**

If the accessories used with the product are not properly secured and the product is subjected to mechanical shock, for example blows or falling, the product may be damaged or people can sustain injury.

Precautions:

When setting-up the product, make sure that the accessories are correctly adapted, fitted, secured, and locked in position.

Avoid subjecting the product to mechanical stress



Caution - During the transport, shipping or disposal of batteries it is possible for inappropriate mechanical influences to constitute a fire hazard.

Precautions: Before shipping the product or disposing of it, discharge the batteries by running the product until they are flat. When transporting or shipping batteries, the person in charge of the product must ensure that the applicable national and international rules and regulations are observed. Before transportation or shipping, contact your local passenger or freight transport company.

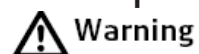

Warning

Batteries not recommended by GeoMax can be damaged if charged or discharged. They may burn and explode.

Precautions:

Only charge and discharge batteries recommended by GeoMax.



Warning - Using a battery charger not recommended by GeoMax can destroy the batteries. This can cause fire or explosions.

Precautions: Only use chargers recommended by GeoMax to charge the batteries.



Warning - High mechanical stress, high ambient temperatures or immersion into fluids can cause leakage, fire or explosions of the batteries.

Precautions: Protect the batteries from mechanical influences and high

ambient temperatures. Do not drop or immerse batteries into fluids.



Warning - If battery terminals come in contact with jewellery, keys, metalised paper or other metals, short circuited battery terminals can overheat and cause injury or fire, for example by storing or transporting in pockets.

Precautions: Make sure that the battery terminals do not come into contact with metallic objects.



Warning - If the product is improperly disposed of, the following can happen:

- If polymer parts are burnt, poisonous gases are produced which may impair health.
- If batteries are damaged or are heated strongly, they can explode and cause poisoning, burning, corrosion or environmental contamination.
- By disposing of the product irresponsibly you may enable unauthorised persons to use it in contravention of the regulations, exposing themselves and third parties to the risk of severe injury and rendering the environment liable to contamination.
- Improper disposal of silicone oil may cause environmental contamination.

Precautions: The product must not be disposed with household waste.

Dispose of the product appropriately in accordance with the national regulations in force in your country.

Always prevent access to the product by unauthorized personnel.

Product specific treatment and waste management information can be downloaded from the GeoMax AG



 Warning

Only GeoMax authorized service workshops are entitled to repair these products.

Laser Classification

General

The following directions (in accordance with the state of the art-international standard IEC 60825-1 (2007-03) and IEC TR 60825-14 (2004-02)) provide instruction and training information to the person responsible for the product and the person who actually uses the equipment, to anticipate and avoid operational hazards.



Products classified as laser class 1, class 2 and class 3R do not require:

- laser safety officer involvement,
 - protective clothes and eyewear,
 - special warning signs in the laser working area.
- if used and operated as defined in this user manual due to the low eye hazard level.



Products classified as laser class 2 or class 3R may cause dazzle, flash-blindness and afterimages, particularly under low ambient light conditions.

Distancer, Measurements without Reflectors

The EDM module built into the product produces a visible laser beam which emerges from the telescope objective.

The laser product described in this section is classified as laser class 3R in accordance with:

- IEC 60825-1 (2007-03): "Safety of laser products".
- EN 60825-1 (2007-10): "Safety of laser products".

Class 3R laser products:

Direct intrabeam viewing may be hazardous (low-level eye hazard), in particular for deliberate ocular exposure. The risk of injury for laser class 3R products is limited because of:

- unintentional exposure would rarely reflect worst case conditions of (e.g.) beam alignment with the pupil, worst case accommodation,
- inherent safety margin in the maximum permissible exposure to laser radiation (MPE)
- natural aversion behaviour for exposure to bright light for the case of visible radiation.

Description	Value
Maximum average radiant power	4.75 mW
Pulse duration	400 ps
Pulse repetition frequency	320 MHz
Wavelength	650 -690 nm
Beam divergence	0.2 mrad x 0.3 mrad
NOHD (Nominal Ocular Hazard Distance) @ 0.25s	67 m / yy ft.



Warning - From a safety perspective class 3R laser products should be treated as potentially hazardous.

Precautions: Prevent direct eye exposure to the beam. Do not direct the beam at other people.



Warning - Potential hazards are not only related to direct beams but also to reflected beams aimed at reflecting surfaces such as prisms, windows, mirrors, metallic surfaces etc.

Precautions:

Do not aim at areas that are essentially reflective, such as a mirror, or which could emit unwanted reflections.

Do not look through or beside the optical sight at prisms or reflecting objects when the laser is switched on, in laser pointer or distance measurement mode. Aiming at prisms is only permitted when looking through the telescope.

Distancer, Measurements with Reflectors

The EDM module built into this product produces a visible laser beam which emerges from the telescope objective.

The laser product described in this section, is classified as laser class 1 in accordance with:

- IEC 60825-1 (2007-03): "Safety of laser products".
- EN 60825-1 (2007-10): "Safety of laser products".



Class 1 laser products are safe under reasonably foreseeable conditions of operation and are not harmful to the eyes provided that the products are used and maintained in accordance with this user manual.

Description	Value
<i>Maximum average radiant power</i>	<i>0.33 mW</i>
Pulse duration	<i>400 ps</i>
Pulse repetition frequency	<i>320 MHz</i>
Wavelength	<i>650 -690 nm</i>

Laser Plummet

The laser plummet built into the product produces a visible red laser beam which emerges from the bottom of the product.

The laser product described in this section, is classified as laser class 2 in accordance with:

- IEC 60825-1 (2007-03): "Safety of laser products".
- EN 60825-1 (2007-10): "Safety of laser products".



These products are safe for momentary exposures but can be hazardous for deliberate staring into the beam.



Warning - From a safety perspective class 2 laser products are not inherently safe for the eyes.

Precautions:

Avoid staring into the beam or pointing the beam at other people.

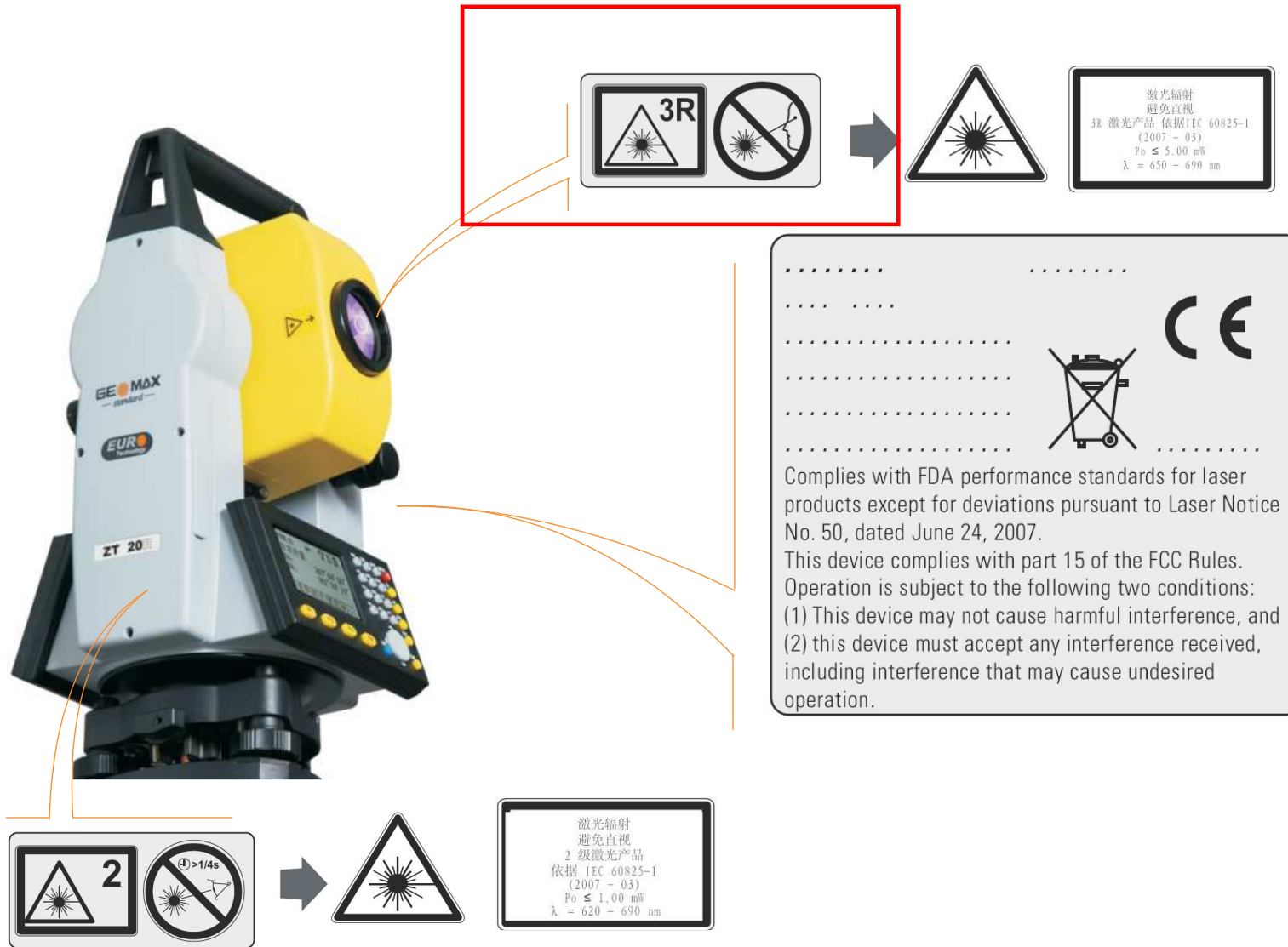

Electromagnetic Compatibility EMC

The term Electromagnetic Compatibility is taken to mean the capability of the product to function smoothly in an environment where electromagnetic radiation and electrostatic discharges are present, and without causing electromagnetic disturbances to other equipment.



Warning-Electromagnetic radiation can cause disturbances in other equipment.

Although the product meets the strict regulations and standards which are in force in this respect, GeoMax cannot completely exclude the possibility that other equipment may be disturbed.



Caution - There is a risk that disturbances may be caused in other equipment if the product is used with accessories from other manufacturers, for example field computers, personal computers, two-way radios, non-standard \cables or external batteries.

Precautions: Use only the equipment and accessories recommended by GeoMax. When combined with the product, they meet the strict requirements stipulated by the guidelines and standards. When using computers and two-way radios, pay attention to the information about electromagnetic compatibility provided by the manufacturer.



Caution - Disturbances caused by electromagnetic radiation can result in erroneous measurements. Although the product meets the strict regulations and standards which are in force in this respect, GeoMax cannot completely exclude the possibility that the product may be disturbed by intense electromagnetic radiation, for example, near radio transmitters, two-way radios or diesel generators.

Precautions: Check the plausibility of results obtained under these



conditions. **Warning** - If the product is operated with connecting cables

attached at only one of their two ends, for example external supply cables, interface cables, the permitted level of electromagnetic radiation may be exceeded and the correct functioning of other products may be impaired.

Precautions: While the product is in use, connecting cables, for example product to external battery, product to computer, must be connected at both ends.

Radios or digital cellular phones

Use of product with radio or digital cellular phone devices:



Electromagnetic fields can cause disturbances in other equipment, in installations, in medical devices, for example pacemakers or hearing aids and in aircraft. It can also affect humans and animals.

Precautions:

Although the product meets the strict regulations and standards which are in force in this respect, GeoMax cannot completely exclude the possibility that other equipment can be disturbed or that humans or animals can be affected.

- Do not operate the product with radio or digital cellular phone devices in the vicinity of filling stations or chemical installations, or in other areas where an explosion hazard exists.
- Do not operate the product with radio or digital cellular phone devices near medical equipment.
- Do not operate the product with radio or digital cellular phone devices in aircraft.

FCC Statement, Applicable in U.S.

Applicability

The grayed paragraph below is only applicable for ZT20 instruments without radio

Warning

This equipment has been tested and found to comply with the limits for a Class B digital device, pursuant to part 15 of the FCC rules.

These limits are designed to provide reasonable protection against harmful interference in a residential installation.

This equipment generates, uses and can radiate radio frequency energy and, if not installed and used in accordance with the instructions, may cause harmful interference to radio communications. However, there is no guarantee that interference will not occur in a particular installation.



If this equipment does cause harmful interference to radio or television reception, which can be determined by turning the equipment off and on, the user is encouraged to try to correct the interference by one or more of the following measures:

- Reorient or relocate the receiving antenna.
- Increase the separation between the equipment and the receiver.
- Connect the equipment into an outlet on a circuit different from that to which the receiver is connected.
- Consult the dealer or an experienced radio/TV technician for help.

 **Warning**

Changes or modifications not expressly approved by Geomax for compliance could void the user's authority to operate the equipment.

.....
.....
.....
.....
.....



Complies with FDA performance standards for laser products except for deviations pursuant to Laser Notice No. 50, dated June 24, 2007.
This device complies with part 15 of the FCC Rules.
Operation is subject to the following two conditions:
(1) This device may not cause harmful interference, and
(2) this device must accept any interference received, including interference that may cause undesired operation.

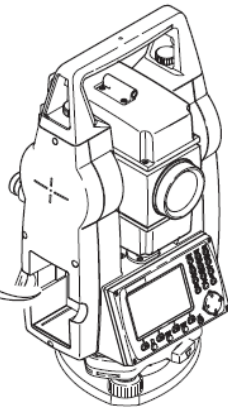



This device complies with part 15 of the FCC Rules. Operation is subject to the following two conditions: (1) This device may not cause harmful interference, and (2) this device must accept any interference received, including interference that may cause undesired operation.

UL US LISTED
ITE Accessory
E179078 . 70YL

Technical Data

Contents:

- General Technical Data of the Instrument
- Scale Correction
- Reduction Formulas

Chapter 11

General Technical Data of the Instrument

Telescope

Magnification	30x
Free Objective aperture	40mm
Focusing	1.7m to infinity
Field of view	1°30'
	2.6m at 100m

Angle Measurement

Characteristics	Absolute, continuous, diametric.
Accuracy	2"
Mean display resolution	
degree	0.0001/0.0005/0.001
°"	1"/5"/10"
mil	0.01/0.001/0.05/0.1
gon	0.1mgon/0.5mgon/1mgon

Distance Measurement

Type	Coaxial, visible red laser
Laser Classification	
Prism mode	class 1
Non-Prism mode	class 3R
Principle	Phase measurement
Laser dot size	12mm x 24mm at 50m

Range

Prism mode	
With single prism	3500m
Non-prism mode	
Kodak Gray Card, White side	280m

Accuracy

P- Std	2mm+2ppm
NP-Std	3mm+2ppm

Measure time

Prism mode	
Standard	2 s
Quick	0.8 s
tracking	0.15 s
Non-Prism mode	
Standard	0.15~4 s

Dimensions

Instrument Dimensions

height (with handle and tribrach) 360mm ± 5mm

width 174mm

length 150mm

Instrument container (length,width,height) 468 × 254 × 355mm

Weight

With battery and tribrach 6.18 Kg

Tilting axis height

Without tribrach	196mm
With tribrach	240 ± 5mm

Level sensitivity

Tubular level	30" /2mm
Circular level	8'/2mm

Compensation

Type	2-axis, liquid
Setting range	± 3'
Setting accuracy	5"

Laser plummet

Location	In standing axis of instrument
Diameter of laser point	2.5 mm at 1.5 m instrument height
Type	Visible red laser class 2
Accuracy	1.5 mm at 1.5 m instrument height

Operation

Operating system	WinCE 6.0
Display	
Resolution	160 × 96 pixels
LCD	backlit
Number of keys	23

Battery ZBA301

Type	Li-Ion
Voltage	7.4V
Capacity	4400mAh
Operating time	approximately 10 hours

Environmental specifications

Operating temperature	-20° C to +50° C
Storage temperature	-40° C to +70° C
Protection against water, dust and sand	IP54

Communication

Job capacity	25
Data capacity	20,000 blocks
Port	USB
Data format	GSI/South/Topcon/Other

Scale Correction

Use of scale correction

By entering a scale correction, reductions proportional to distance can be taken into account.

- Atmospheric correction.
- Reduction to mean sea level.
- Projection distortion.

Atmospheric correction

The distance displayed is correct if the scale correction in ppm, mm/km, which has been entered corresponds to the atmospheric conditions prevailing at the time of the measurement.

The atmospheric correction includes:

- Adjustments for air pressure
- Air temperature

For highest precision distance measurements, the atmospheric correction should be determined with:

- An accuracy of 1 ppm
- Air temperature to 1 °C
- Air pressure to 3 mbar

Atmospheric corrections in ppm with temperature [°C], air pressure [mb] and height [m] at 60 % relative humidity.

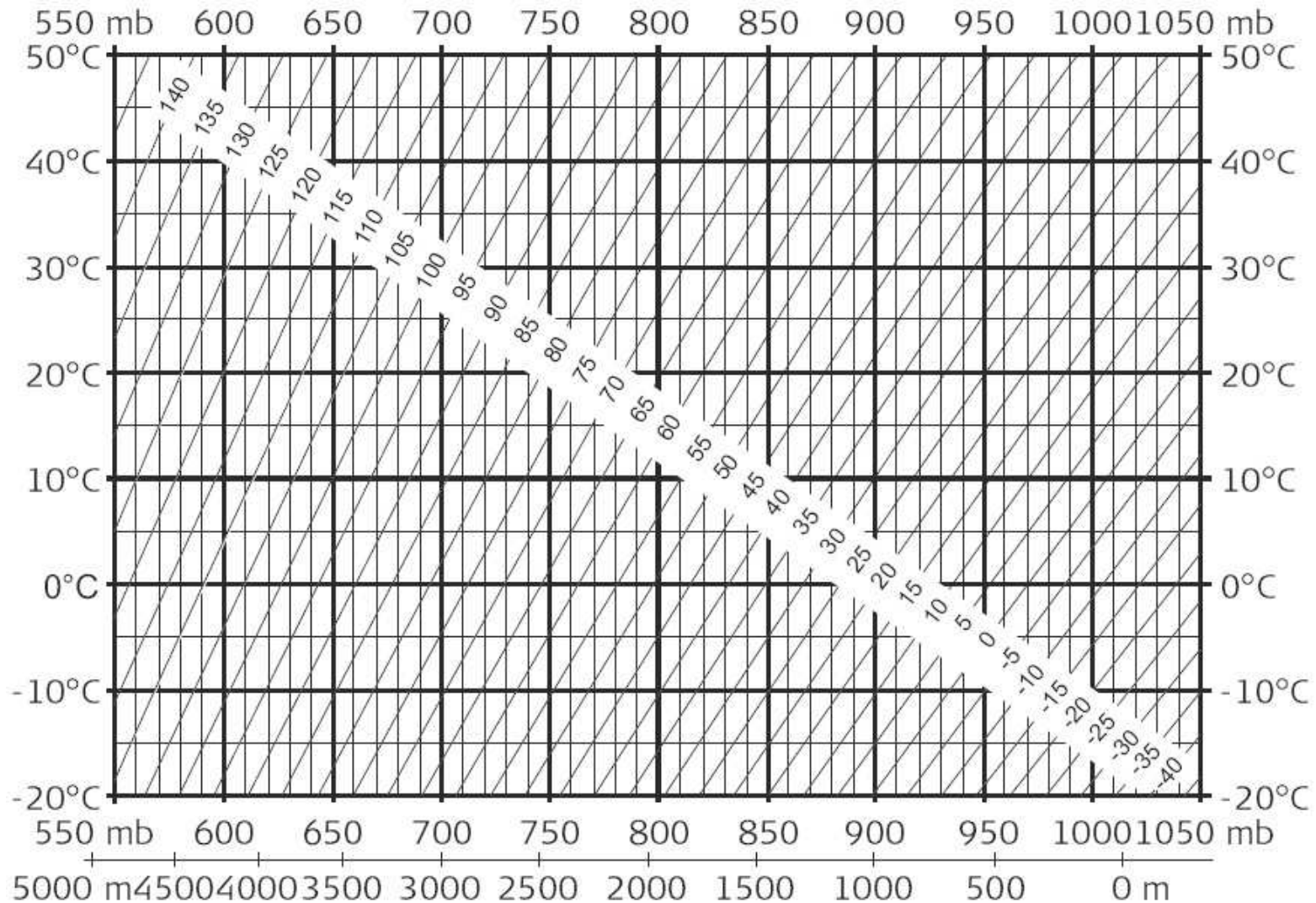

Atmospheric corrections in ppm with temperature [°F], air pressure [inch Hg] and height [ft] at 60 % relative humidity.

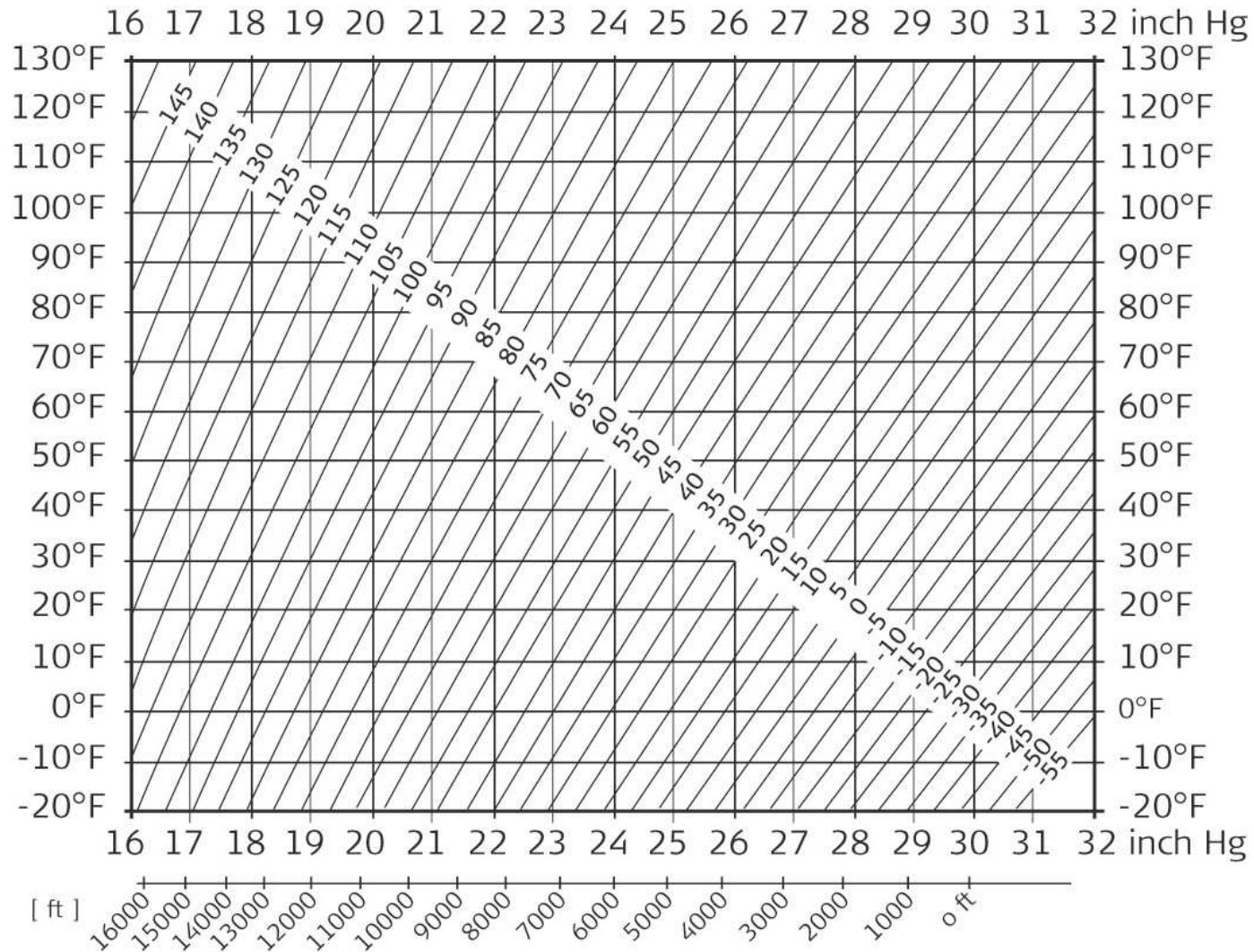

Reduction Formulas

The instrument calculates the slope distance, horizontal distance, and height difference in accordance with the following formulas. Earth curvature ($1/R$) and mean refraction coefficient ($k = 0.13$) are automatically taken into account when calculating the horizontal distance and height difference. The calculated horizontal distance relates to the station height and not to the reflector height.

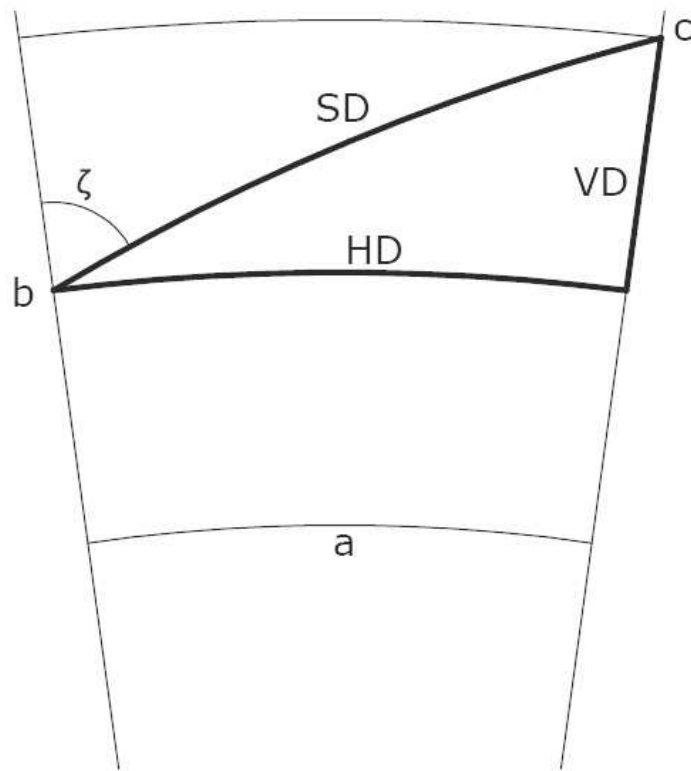

- a Mean Sea Level
- b Instrument
- c Reflector
- SD Slope distance
- HD Horizontal distance
- VD Height difference

Slope distance

$$SD = D_0 \cdot (1 + \text{ppm} \cdot 10^{-6}) + \text{mm}$$

SD	Displayed slope distance [m]
D0	Uncorrected distance [m]
ppm	Atmospheric scale correction [mm/km]
mm	prism constant [mm]

Horizontal distance

$$HD = Y - A \cdot X \cdot Y$$

HD	Horizontal distance [m]
Y	$SD \times \sin \zeta$
X	$SD \times \cos \zeta$
	$\zeta =$ Vertical circle reading
A	$(1 - k/2)/R = 1.47 \times 10^{-7} [m^{-1}]$
	$k = 0.13$ (mean refraction coefficient)
	$R = 6.378 \times 10^6$ m (radius of the earth)

Height difference

$$VD = X + B \cdot Y^2$$

VD	Height difference [m]
Y	$SD \times \sin \zeta$
X	$SD \times \cos \zeta$
	$\zeta =$ Vertical circle reading
B	$(1 - k)/2R = 6.83 \times 10^{-8} [m^{-1}]$
	$k = 0.13$ (mean refraction coefficient)
	$R = 6.378 \times 10^6$ m (radius of the earth)

Conformity to National Regulations (For products which do not fall under R&TTE directive)



Hereby, GeoMax AG, declares that the product [ZT20] in compliance with the essential requirements and other relevant provisions of applicable European Directives. The declaration of conformity is available from GeoMax AG.

Conformity to National Regulations (Class 1 R&TTE products)

FCC Part 15 (applicable in US)

Hereby, GeoMax AG, declares that the product [ZT20] is in compliance with the essential requirements and other relevant provisions of Directive 1999/5/EC. The declaration of conformity is available from GeoMax AG.



Class 1 equipment according European Directive 1999/5/EC (R&TTE) can be placed on the market and be put into service without restrictions in any EEA member state.

The conformity for countries with other national regulations not covered by the FCC part 15 or European directive 1999/5/EC has to be approved prior to use and operation.

International Limited Warranty, Software Licence Agreement

International Limited Warranty

This product is subject to the terms and conditions set out in the International Limited Warranty which you can download from the GeoMax home page at <http://www.geomax-positioning.com/internationalwarranty> or collect from your GeoMax distributor. The foregoing warranty is exclusive and is in lieu of all other warranties, terms or conditions, express or implied, either in fact or by operation of law, statutory or otherwise, including warranties, terms or conditions of merchantability, fitness for a particular purpose, satisfactory quality and non-infringement, all which are expressly disclaimed.

Software Licence Agreement

This product contains software that is preinstalled on the product, or that is supplied to you on a data carrier medium, or that can be downloaded by you online according to prior authorisation from GeoMax. Such software is protected by copyright and other laws and its use is defined and regulated by the GeoMax Software Licence Agreement, which covers aspects such as, but not limited to, Scope of the Licence, Warranty, Intellectual Property Rights, Limitation of Liability, Exclusion of other Assurances, Governing Law and Place of Jurisdiction. Please make sure, that at any time you fully comply with the terms and conditions of the GeoMax Software Licence Agreement.

Such agreement is provided together with all products and can also be referred to and downloaded at the GeoMax home page at <http://www.geomax-positioning.com/swlicense> or collected from your GeoMax distributor.

You must not install or use the software unless you have read and accepted the terms and conditions of the GeoMax Software Licence Agreement. Installation or use of the software or any part thereof, is deemed to be an acceptance of all the terms and conditions of such Licence Agreement. If you do not agree to all or some of the terms of such Licence Agreement, you must not download, install or use the software and you must return the unused software together with its accompanying documentation and the purchase receipt to the distributor from whom you purchased the product within ten (10) days of purchase to obtain a full refund of the purchase price.