

GeoMax Zipp02



Introduction

Purchase

Congratulations on the purchase of a Zipp02 instrument.



This manual contains important safety directions as well as instructions for setting up the product and operating it. Refer to "7 Safety Directions" for further information.



Read carefully through the User Manual before you switch on the product.

Product identification

The type and serial number of your product are indicated on the type plate. Enter the type and serial number in your manual and always refer to this information when you need to contact your agency or GeoMax authorised service workshop.

Type: _____

Serial No.: _____

Symbols

The symbols used in this manual have the following meanings:





Type	Description
 Danger	Indicates an imminently hazardous situation which, if not avoided, will result in death or serious injury.
 Warning	Indicates a potentially hazardous situation or an unintended use which, if not avoided, could result in death or serious injury.
 Caution	Indicates a potentially hazardous situation or an unintended use which, if not avoided, may result in minor or moderate injury and/or appreciable material, financial and environmental damage.
	Important paragraphs which must be adhered to in practice as they enable the product to be used in a technically correct and efficient manner.

Table of Contents

In this manual

Chapter	Page
1 Description of the System	7
1.1 Instrument Case	7
1.2 Instrument Components	8
2 User Interface	10
2.1 Function of Buttons	10
2.2 Display	13
3 Preparation before Measurement	14
3.1 Preparation of Battery	14
3.2 Erection of the Instrument	16
3.3 Leveling up of the Instrument	16
3.4 Centering	17
3.5 Collimation	18
3.6 Initial Settings	19

4	Operation Method	23
4.1	Start Up	23
4.2	Measurement of Angle	24
4.3	Turning Off the Instrument	28
4.4	Measuring Distance Using the Stadia Method	29
4.5	Installation and Removal of the Base	30
5	Inspection and Adjustment	31
5.1	Tubular Vial	31
5.2	Circle Vial	32
5.3	Laser Plummet	32
5.4	Perpendicular of Vertical Hair of Reticle of Telescope	34
5.5	Collimation Error	35
5.6	Index Error of Vertical Circle	36
6	Care and Transport	38
6.1	Transport	38
6.2	Storage	39
6.3	Cleaning and Drying	40

7	Safety Directions	42
7.1	General	42
7.2	Intended Use	42
7.3	Limits of Use	43
7.4	Responsibilities	44
7.5	Hazards of Use	45
7.6	Laser Classification	52
7.6.1	General	52
7.6.2	Laser Plummet	53
7.7	Electromagnetic Compatibility EMC	55
8	Technical Data	58
8.1	Technical Data of the Instrument	58
8.2	Conformity to National Regulations	60
9	International Limited Warranty	61
10	Accessories	62
11	Error Information	63

1 Description of the System

1.1 Instrument Case

Instrument case

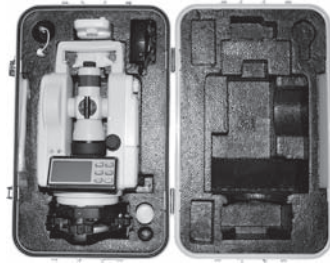

Before placing the instrument into the instrument case, align the dot mark of the instrument upward and on the same line, and lightly tighten the clamp knobs and loosened after the instrument is placed in the case. All the clamp knobs must be slightly tightened again after the instrument is in place in the case.

1.2 Instrument Components

Instrument components part 1 of 2

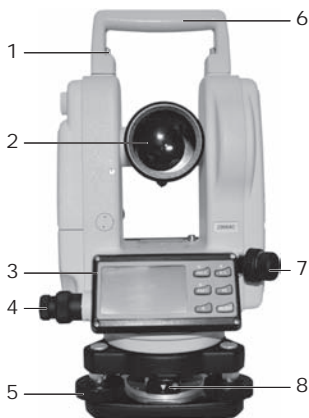

1. Screw of handle
 2. Objective lens
 3. LCD display I
 4. Horizontal drive
 5. Levelling screw
 6. Handle
 7. Laser plummet
 8. Tribrach locking lever
-

**Instrument
components part
2 of 2**

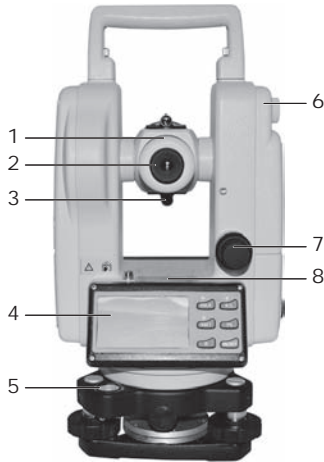

1. Focusing knob
2. Eyepiece
3. Optical sight
4. LCD display II
5. Circular vial
6. Battery case
7. Vertical drive
8. Tubular vial

2 User Interface

2.1 Function of Buttons





Description



1. R/L button
2. HOLD button
3. V% button
4. OSET button
5. ON/OFF button
6. Light button

Buttons

Button	Function 1	Other
ON/OFF	Switch the instrument On/Off	<ol style="list-style-type: none"> 1. One of the function buttons for entering into initial setting of the instrument. 2. One of the function buttons for entering into index error setting. 3. One of the function buttons for entering into compensation setting.

Button	Function 1	Other
	Button for lighting of Reticle and LCD display	<ol style="list-style-type: none"> 1. One of the function buttons for entering into time setting. 2. Confirming button of time setting.
 OSET	Set horizontal angle to zero (zeroing)	<ol style="list-style-type: none"> 1. Menu selection button in initial setting. 2. One of the function buttons for entering into compensation setting. 3. One of the function buttons for entering into initial setting of the instrument.
 HOLD	Hold/release horizontal angle reading	<ol style="list-style-type: none"> 1. Menu selection button in initial setting. 2. One of the function buttons for entering into initial setting of the instrument. 3. One of the function buttons for entering into index error setting. 4. Selecting button of time setting.
 R/L	Switch between left and right increment of horizontal angle reading	<ol style="list-style-type: none"> 1. Menu selection button in initial setting. 2. One of the function buttons for entering into initial setting of the instrument. 3. Plus number to change the time.

Button	Function 1	Other
V%	Switch between display of vertical angle in angle unit or as percentage of slope	<ol style="list-style-type: none"> 1. One of the function buttons for entering into initial setting of the instrument. 2. Button for confirmation after initial setting of the instrument. 3. Minus number to change the time.

2.2 Display

Description

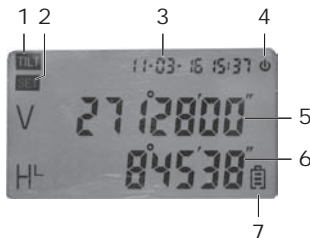

1. TILT
2. SET
3. Date and time
4. Auto power off
5. Vertical angel
6. Horizontal angel
7. Battery

Elements

Type	Description
TILT	"TILT" is displayed, as long as the compensator is "on".
SET	"SET" is displayed, as long as working in "set initial conditions".
Date and time	Shows the current date and time, according to the settings.
Auto power off	⏻ is displayed, when the auto power off function is "ON".
Battery	The battery symbol shows the current battery power level.

3 Preparation before Measurement

3.1 Preparation of Battery

Checking electric quantity

Refer to "4.1 Start Up" on how to check the power status of the battery.



Before removal of any battery, the instrument must be switched off to avoid malfunction.

Removal of AA-battery case



1. Turn the knob of the battery case and let the mark ▼ point to **UNLOCK**, take the battery case off.
2. Open the case cover, insert four AA batteries into the battery case according to + and -.



3. Insert the raised part at the bottom of the battery case into the slot of the right battery cover, and put the battery case in place. Then turn the knob and let the mark ▼ point to **LOCK**.



- The four batteries in the battery case should be of the same type.
- Do not use batteries which have different remaining capacities.
- When batteries are wet, dry them immediately, and put them out of the instrument case, air-dry thoroughly.

Recharging the Ni-MH battery pack

1. Connect the charger to a power source as indicated on the label of the charger. The green light on the charger is lit.
2. Insert the plug of the charger to the charging port of the Ni-MH battery pack. The green light of the charger turns red, the charging process is started, after 3 to 4 hours when the red light turns green, it indicates that the charging process is finished.

3.2 Erection of the Instrument

Erection of the instrument

1. Stretch the tripod to a proper height.
2. Ensure that the measure point is exactly under the central hole of the tripod head.
3. Level up the tripod (this is very important when centering with plumb bob).
4. Ensure that all locking handles are securely tightened.
5. Secure the instrument to the tripod.

3.3 Leveling up of the Instrument

Leveling up of the instrument

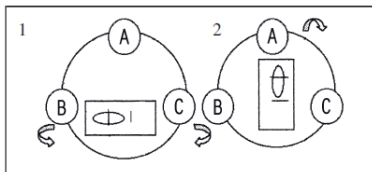

1. Centering the circle vial using leveling screws A, B and C.
2. Turn the collimation unit so that the axis of the tubular vial is parallel to the connecting line of B and C. Adjust B and C so that the tubular vial is centered.

3. Turn the collimation 90° adjust the leveling screw A and make the bubble sit in the center.
4. Repeat 2. to 3., until the bubble is in the center for both directions.

5. After 2. is finished, turn collimation unit for 180° . If the tubular vial is still centered, the leveling up of the instrument is finished. If the bubble strays from the center, perform leveling up with the procedure for adjustment of tubular vial in "5.1 Tubular Vial".
-

3.4 Centering

Centering with plumb bob

1. Tie the plumb bob wire to the hook on the central screw. Adjust the length of the wire so that the tip of the bob is 2 mm above ground.
 2. Loosen the central screw and move the base so that the tip of the plumb bob is precisely positioned to the ground point (when observed from two directions perpendicular to each other).
-

Centering with Optical plummet

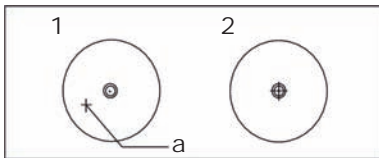

To ensure maximum measuring precision, we recommend the performance of the steps described in "5 Inspection and Adjustment" before using this instrument.

1. Turn the knob of the eyepiece of the optical plummet so that the reticle is in focus; turn the focusing knob so that the ground point **a** is in focus. Then, loosen the central screw to translate the whole instrument (be sure

not to turn the instrument) so that the ground point coincides with the central point of the reticle. Retighten the central screw.

2. Perform precise leveling up of the instrument as described in "3.3 Leveling up of the Instrument" and repeat the operation in 1. of "3.4 Centering", "Centering with Optical plummet" until the instrument is precisely leveled up and the center of the reticle of the optical plummet precisely coincides with the ground point as shown.
-

3.5 Collimation

Adjustment of dioptr

1. Aim with the telescope on a bright background.
 2. Turn the eyepiece knob so that the cross hairs of the reticle are clearly seen.
-

Elimination of optical parallax

1. Adjust the focusing knob so that the object forms image on the reticle.
 2. Move your eyes up and down to see if the image of the object moves relative to the graduation lines.
If it does not move, there is no optical parallax; otherwise turn the focusing knob to eliminate the optical parallax.
-



3.6 Initial Settings



Before start measuring, please confirm all initial settings. Items in bold indicate factory settings.

Initial Setting	Selection		
1. Unit of angle	360° UNIT A	400G UNIT B	6400 UNIT C
2. Zenith angle	ZEN==0°	ZEN==90°	
3. Auto power off time	30 OFF	NO OFF	
4. Minimum display resolution	DSP 1	DSP 5	
5. Tilt sensor switch	TILT ON	TILT OFF	
6. Indication of position of horizontal angle	NO BEEP	90 BEEP	

Method of setting

1. Press and hold **HOLD** button + **OSET** button and press **ON/OFF** button.
2. Release **ON/OFF** button when full character display appears and release **HOLD** + **OSET** buttons when four beeps are heard.
The instrument enters into initial setting mode and the LCD displays:
3. Press  button or  button for turning over pages and selecting options.
4. Press  button for selecting specific content in the options.
5. Finally, press **V%** button to confirm and enter into angle measuring mode.



Setting of items

1. Unit of angle
 - UNIT A: 360° (Degree)
 - UNIT B: 400 (GON)
 - UNIT C: 6400 (Mil)
2. Zero position of vertical angle
 - ZEN==0: Zenith being 0°
 - ZEN==90: Zenith being 90°

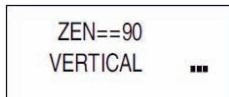

3. Auto power off time

- NO OFF: Auto power off disabled
- 30 OFF: Turns power off if no action is done within 30 min

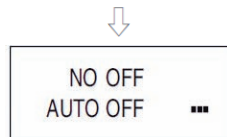

4. Minimum display resolution

- DSP 1: minimum display being 1"
- DSP 5: minimum display being 5"
- DSP 10: minimum display being 10"

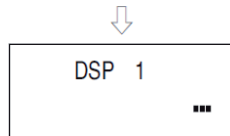

5. Setting of tilt sensor

- V TILT ON: Turn on the tilt sensor
- V TILT OFF: Turn off the tilt sensor

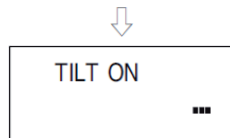

6. Indication of horizontal angle

- NO BEEP: Horizontal angle indicator disabled
- 90 BEEP: Gives out beep when the instrument is close to 0°, 90°, 180° and 270°



Set Date & Time

Press and hold LIGHT and OSET button while turning on the instrument. The instrument shows ADJ2 and will switch automatically to the settings for date and time. Press HOLD to move between fields, R/L to increase, V% to decrease. Press LIGHT button to confirm and exit.

4 Operation Method

4.1 Start Up

Start up

1. Press and hold **ON/OFF** button.
 2. Release **ON/OFF** button when full character display appears:
- 
3. Sway the telescope up and down ward when the instrument is at the normal position. The beeper beeps and LCD displays vertical angle. The instrument enters into measuring mode.
 4. After the power is switched on and the instrument has entered into measuring mode, the battery power level is indicated by the battery symbol in the lower right corner of LCD.
 - If three bars are shown the battery is fully charged.
 - A flashing battery symbol indicates a low power status of the battery. Turn off the instrument and change to a new battery to avoid an automatic switch off by the instrument.

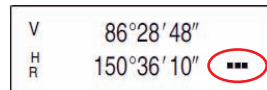
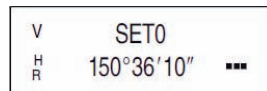

4.2 Measurement of Angle

Observing in the "Normal" and "Reverse" Positions of the Telescope

The normal position of the telescope refers to observation with the object lens facing right ahead (the vertical encoder being on the left); the reverse position refers to observation with the object lens facing right ahead (the vertical encoder being on the right). The mechanical errors can be offset by the average of the values of measured in the normal and reverse positions.



Normal



Reverse

Measurement of vertical angle

1. Measurement of 0° angle of vertical angle

0° angle position can be set as follows in the initial setting:



2. Compensation of the tilt sensor to vertical angle

- The working range of the vertical tilt sensor is $\pm 3'$. Within this range the vertical readings will be corrected.

V	90°00'10"	
H	108°36'38"	...
R		



- If the inclination is greater than $\pm 3'$, the instrument will display as shown in the figure

V	TILT	
H R	108°36'38"	...

3. Display of slope

Press **V%** button, the vertical angle display is turned into slope display; press **V%** button, the vertical angle display is resumed.

V	69°11'00"	
H R	108°36'38"	...



When vertical angle is turned into slope, the precision of slope is to the fourth digit after the decimal.

The value of the slope is shown in the range of $\pm 99.99\%$ ($\pm 45^\circ$); outside of this range no value is displayed.

V	38.88%	
H R	108°36'38"	...



V	69°11'00"	
H R	108°36'38"	...

Measurement of horizontal angle

1. Reset of horizontal angle

Press **OSET** button.

The horizontal angle returns to zero.

V	90°00'10"	
H R	150°36'10"	...



V	90°00'10"	
H R	00°00'00"	...

2. Selecting the direction of measurement of horizontal angle

Press **R/L** button to change the direction of measurement of horizontal angle.

V	90°00'10"	
H R	150°36'10"	...



V	90°00'10"	
H L	209°23'50"	...

- When **HR** is displayed, the angle increases with clockwise turning of the collimation unit.
- When **HL** is displayed, the angle increases with counter-clockwise turning of the collimation unit.

3. Holding horizontal angle

Press **HOLD** button, the horizontal angle will be held; the reading of the horizontal angle will remain unchanged even if the direction of collimation is changed.

V	90°00'10"	
H R	150°36'10"	---



Press **HOLD** button again, the hold of horizontal angle is released.

V	90°00'10"	
H R	150°36'10"	---

4.3 Turning Off the Instrument

Turning off

1. Press **ON/OFF** button.
OFF will be displayed at the position of vertical angle display after a beep.
2. Release **ON/OFF** button.
The instrument is turned off.

V	OFF	
H R	150°36'10"	---

4.4 Measuring Distance Using the Stadia Method

Measuring distance using the Stadia method

1. Take reading l from the staff gauge using the Stadia hair on the reticle of the telescope.
2. Multiply reading l by 100, we obtain the actual distance L from the target to the measured point. (100 is the multiplication constant error of the instrument, i.e., $L = l \times 100$)

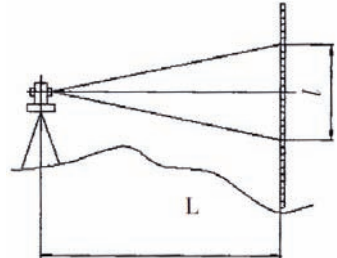
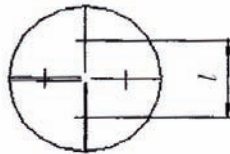

4.5 Installation and Removal of the Base

Remove of the base



1. Turn the screw on knob **a** outward using flat screw driver until it no more limits position.
2. Turn knob **a** counter-clockwise, holding the base with one hand and take the main body of the instrument off the base.

Installation of the base



1. Turn the knob **a** counter-clockwise until it reaches the position limit.
 2. Make the positioning block **b** on the main body of the instrument in line with the notch **c** on the base and install the main body onto the base as shown.
 3. Turn the knob **a** clockwise until it reaches the position limit so that the  mark points downward.
 4. Turn the screw until it can limit position.
-

5 Inspection and Adjustment

5.1 Tubular Vial

Inspection

1. Fix the instrument to the tripod and roughly level up the instrument and make the tubular vial parallel to the connecting line of two of the three leveling screws on the base. Adjust the two leveling screws so that the tubular vial is centered.
 2. Turn the instrument 180° and check if the water bubble remains at the center.
 3. If the water bubble remains at the center, no adjustment is required; otherwise, perform adjustment as follows.
-

Adjustment



1. Adjust the bubble adjusting screw so that the bubble moves toward tube center for half the off-center.
 2. Turn the leveling screw to correct the other half off-center so that the bubble stays at the center.
 3. Repeat the steps in "Inspection" and "Adjustment" until the long water level is centered when the instrument is at any position.
-

5.2 Circle Vial



Inspection and Adjustment



After making sure that the long water level is correctly adjusted, check if there is any off-center with the round water level. If there is no off-center, no adjustment is required; otherwise, adjust the three adjustment screws with needle as shown to center the bubble.

5.3 Laser Plummet

Turning the laser plummet on/off

With turned on instrument turn on the laser plummet by pushing the  button on the keyboard. To turn off the laser plummet, press the  button again.

Inspection

1. Set the instrument on the tripod (no adjustment is required).
2. Place the cross mark exactly under the instrument.
3. With turned on instrument turn on the laser plummet by pushing the  button.

4. Turn the instrument for 180°.
5. If the laser point remains at the center of the cross mark, no adjustment is required; otherwise adjust as follows.

Adjustment

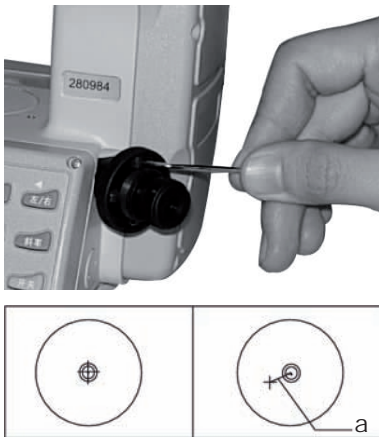

1. Remove the protective cover of the laser plummet and adjust the adjustment screws of the laser plummet, using the hexagonal wrench, so that the laser point moves the half of the offset *a* towards the cross mark.
2. Repeat the steps 2. to 5. in "Inspection" and step 1. in "Adjustment" until the laser point superposition.

5.4 Perpendicular of Vertical Hair of Reticle of Telescope

Inspection

1. Fix the instrument on the tripod and perform precise leveling up.
2. Set a target point A 50 m away from instrument.
3. Aim the telescope at target point A and adjust the vertical fine movement. If point A moves along the vertical hair of the reticle, no adjustment is required; perform adjustment if the target point A strays from the vertical hair.

Adjustment

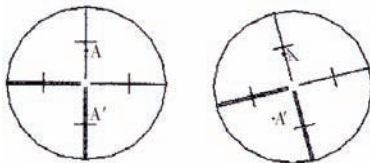

1. Remove the protective cover of the reticle and slightly loosen the four adjusting screws. Turn the assembly so that point A coincides with the vertical hair. Retighten the four adjusting screws.
2. Repeat step 3. in "Inspection" and step 1. in "Adjustment" until there is no error.

5.5 Collimation Error

Inspection

1. Fix the instrument on the tripod and perform precise leveling up.
2. Aim at object point A in the distance with the normal position of telescope and take the reading of the horizontal angle HR_{norm} and aim at object A with the reverse position of the telescope and take the reading of the horizontal angle HR_{rev} then:

$$\text{Collimation Error } C = (HR_{norm} - HR_{rev} \pm 180^\circ)/2$$

If $C < 10''$, no adjustment is required; if $C > 10''$, adjustment is required.

Adjustment

1. Adjust the horizontal fine motion in the reverse position of the telescope so that the reverse reading $HR_{rev}' = HR_{rev} + C$.
 2. Remove the protective cover of the reticle of the telescope and adjust both the left and right adjusting screws so that the vertical hair of the reticle coincides with object A.
 3. Repeat the steps in "Inspection" and "Adjustment" until acceptable condition is reached.
-

5.6 Index Error of Vertical Circle

Inspection

1. Fix the instrument on the tripod and perform precise leveling up.
2. Aim the telescope at any object point P in the normal position and take the reading of vertical angle V_{norm} .
3. Turn the telescope to the reverse position and aim it at point P again. Take the reading of other vertical angle V_{Rev} .
4. If $(V_{norm} + V_{Rev}) - 360^\circ = 2I$, $I \leq 15''$, no adjustment is required; otherwise, perform adjustment.

Adjustment

1. Press and hold **R/L + HOLD** buttons and press **ON/OFF** button. Release **ON/OFF** button when full character display appears and release **R/L + HOLD** buttons when four beeps are heard.
2. Sway the telescope near horizontal plane with instrument in the normal position and allow vertical angle to be reset after zero cross. Aim the telescope in the normal position at object P and press **OSET** to confirm.

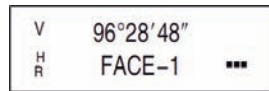

3. Aim the telescope in the reverse position at object P and press **OSET** to confirm. With this, the compensation of index error is completed.

V	272°36'06"
H R	FACE-2 ...



V	90°00'10"
H R	150°36'10" ...

6 Care and Transport

6.1 Transport

Transport in the field

When transporting the equipment in the field, always make sure that you

- either carry the product in its original transport container,
 - or carry the tripod with its legs splayed across your shoulder, keeping the attached product upright.
-

Transport in a road vehicle

Never carry the product loose in a road vehicle, as it can be affected by shock and vibration. Always carry the product in its transport container and secure it.

Shipping

When transporting the product by rail, air or sea, always use the complete original GeoMax packaging, transport container and cardboard box, or its equivalent, to protect against shock and vibration.

Shipping, transport of batteries

When transporting or shipping batteries, the person in charge of the product must ensure that the applicable national and international rules and regulations are observed. Before transportation or shipping, contact your local passenger or freight transport company.

Field adjustment

After transport inspect the field adjustment parameters given in this user manual before using the product.

6.2 Storage

Product

Respect the temperature limits when storing the equipment, particularly in summer if the equipment is inside a vehicle. Refer to "8 Technical Data" for information about temperature limits.

Field adjustment

After long periods of storage inspect the field adjustment parameters given in this user manual before using the product.

Batteries

- Refer to "8 Technical Data" for information about storage temperature range.
- At the recommended storage temperature range, batteries containing a 10% to 50% charge can be stored for up to one year. After this storage period the batteries must be recharged.
- Remove batteries from the product and the charger before storing.
- After storage recharge batteries before using.
- Protect batteries from damp and wetness. Wet or damp batteries must be dried before storing or use.

For Ni-MH battery pack:

- A storage temperature range of 0°C to +20°C/+32°F to 68°F in a dry environment is recommended to minimise self-discharging of the battery.

For alkaline batteries:

- If the equipment is to be stored for a long time, remove the alkaline batteries from the product in order to avoid the danger of leakage.

6.3 Cleaning and Drying

Objective, eyepiece and reflectors

- Blow dust off lenses and prisms.
 - Never touch the glass with your fingers.
 - Use only a clean, soft, lint-free cloth for cleaning. If necessary, moisten the cloth with water or pure alcohol. Do not use other liquids; these may attack the polymer components.
-

Charger and batteries

- Use only a clean, soft, lint-free cloth for cleaning.
-

Fogging of prisms

Reflector prisms that are cooler than the ambient temperature tend to fog. It is not enough simply to wipe them. Keep them for some time inside your jacket or in the vehicle to allow them to adjust to the ambient temperature.

Damp products

Dry the product, the transport container, the foam inserts and the accessories at a temperature not greater than 40°C /104°F and clean them. Do not repack until everything is completely dry. Always close the transport container when using in the field.

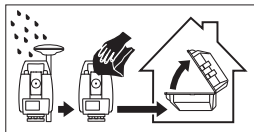

Cables and plugs

Keep plugs clean and dry. Blow away any dirt lodged in the plugs of the connecting cables.

7 Safety Directions

7.1 General

Description

The following directions enable the person responsible for the product, and the person who actually uses the equipment, to anticipate and avoid operational hazards.

The person responsible for the product must ensure that all users understand these directions and adhere to them.

7.2 Intended Use

Permitted use

- Measuring horizontal and vertical angles.
 - Visualizing the aiming direction and vertical axis.
 - Computing by means of software.
-

Adverse use

- Use of the product without instruction.
- Use outside of the intended limits.
- Disabling safety systems.
- Removal of hazard notices.
- Opening the product using tools, for example screwdriver, unless this is specifically permitted for certain functions.

- Modification or conversion of the product.
 - Use after misappropriation.
 - Use of products with obviously recognisable damages or defects.
 - Use with accessories from other manufacturers without the prior explicit approval of GeoMax.
 - Aiming directly into the sun.
 - Inadequate safeguards at the working site, for example when measuring on roads.
 - Deliberate dazzling of third parties.
 - Controlling of machines, moving objects or similar monitoring application without additional control- and safety installations.
-

 **Warning**

Adverse use can lead to injury, malfunction and damage.

It is the task of the person responsible for the equipment to inform the user about hazards and how to counteract them. The product is not to be operated until the user has been instructed on how to work with it.

7.3 Limits of Use

Environment

Suitable for use in an atmosphere appropriate for permanent human habitation: not suitable for use in aggressive or explosive environments.

**Environment
charger**

Suitable for use in dry environments only and not under adverse conditions.



Danger

Local safety authorities and safety experts must be contacted before working in hazardous areas, or close to electrical installations or similar situations by the person in charge of the product.

7.4 Responsibilities

**Manufacturer of
the product**

GeoMax AG, CH-9443 Widnau, hereinafter referred to as GeoMax, is responsible for supplying the product, including the user manual and original accessories, in a safe condition.

**Manufacturers of
non GeoMax
accessories**

The manufacturers of non GeoMax accessories for the product are responsible for developing, implementing and communicating safety concepts for their products, and are also responsible for the effectiveness of those safety concepts in combination with the GeoMax product.

**Person in charge
of the product**

The person in charge of the product has the following duties:

- To understand the safety instructions on the product and the instructions in the user manual.

- To be familiar with local regulations relating to safety and accident prevention.
 - To inform GeoMax immediately if the product and the application becomes unsafe.
-

 **Warning**

The person responsible for the product must ensure that it is used in accordance with the instructions. This person is also accountable for the training and the deployment of personnel who use the product and for the safety of the equipment in use.

7.5 Hazards of Use

 **Warning**

The absence of instruction, or the inadequate imparting of instruction, can lead to incorrect or adverse use, and can cause accidents with far-reaching human, material, financial and environmental consequences.

Precautions:

All users must follow the safety directions given by the manufacturer and the directions of the person responsible for the product.

 **Caution**

Watch out for erroneous measurement results if the product has been dropped or has been misused, modified, stored for long periods or transported.

Precautions:

Periodically carry out test measurements and perform the field adjustments indicated in the user manual, particularly after the product has been subjected to abnormal use and before and after important measurements.

 **Danger**

Because of the risk of electrocution, it is dangerous to use poles and extensions in the vicinity of electrical installations such as power cables or electrical railways.

Precautions:

Keep at a safe distance from electrical installations. If it is essential to work in this environment, first contact the safety authorities responsible for the electrical installations and follow their instructions.

 **Warning**

If the product is used with accessories, for example masts, staffs, poles, you may increase the risk of being struck by lightning.

Precautions:

Do not use the product in a thunderstorm.

 **Caution**

Be careful when pointing the product towards the sun, because the telescope functions as a magnifying glass and can injure your eyes and/or cause damage inside the product.

Precautions:

Do not point the product directly at the sun.

 **Warning**

During dynamic applications, for example stakeout procedures there is a danger of accidents occurring if the user does not pay attention to the environmental conditions around, for example obstacles, excavations or traffic.

Precautions:

The person responsible for the product must make all users fully aware of the existing dangers.

 **Warning**

Inadequate securing of the working site can lead to dangerous situations, for example in traffic, on building sites, and at industrial installations.

Precautions:

Always ensure that the working site is adequately secured. Adhere to the regulations governing safety and accident prevention and road traffic.

 **Warning**

If computers intended for use indoors are used in the field there is a danger of electric shock.

Precautions:

Adhere to the instructions given by the computer manufacturer regarding field use with GeoMax products.

 **Caution**

If the accessories used with the product are not properly secured and the product is subjected to mechanical shock, for example blows or falling, the product may be damaged or people can sustain injury.

Precautions:

When setting-up the product, make sure that the accessories are correctly adapted, fitted, secured, and locked in position.
Avoid subjecting the product to mechanical stress.

 **Caution**

During the transport, shipping or disposal of batteries it is possible for inappropriate mechanical influences to constitute a fire hazard.

Precautions:

Before shipping the product or disposing of it, discharge the batteries by running the product until they are flat.

When transporting or shipping batteries, the person in charge of the product must ensure that the applicable national and international rules and regulations are observed. Before transportation or shipping contact your local passenger or freight transport company.

 **Warning**

Using a battery charger not recommended by GeoMax can destroy the batteries. This can cause fire or explosions.

Precautions:

Only use chargers recommended by GeoMax to charge the batteries.

 **Warning**

High mechanical stress, high ambient temperatures or immersion into fluids can cause leakage, fire or explosions of the batteries.

Precautions:

Protect the batteries from mechanical influences and high ambient temperatures. Do not drop or immerse batteries into fluids.

 **Warning**

If battery terminals come in contact with jewellery, keys, metallised paper or other metals, short circuited battery terminals can overheat and cause injury or fire, for example by storing or transporting in pockets.

Precautions:

Make sure that the battery terminals do not come into contact with metallic objects.

 **Warning**

Batteries not recommended by GeoMax may be damaged if charged or discharged. They may burn and explode.

Precautions:

Only charge and discharge batteries recommended by GeoMax.

 **Warning**

If the product is improperly disposed of, the following can happen:

- If polymer parts are burnt, poisonous gases are produced which may impair health.
- If batteries are damaged or are heated strongly, they can explode and cause poisoning, burning, corrosion or environmental contamination.
- By disposing of the product irresponsibly you may enable unauthorised persons to use it in contravention of the regulations, exposing themselves and third parties to the risk of severe injury and rendering the environment liable to contamination.

Precautions:

The product must not be disposed with household waste.

Dispose of the product appropriately in accordance with the national regulations in force in your country.

Always prevent access to the product by unauthorised personnel.

Product specific treatment and waste management information is available from GeoMax AG.

 **Warning**

Only GeoMax authorised service workshops are entitled to repair these products.



Danger

For the charger:

The product is not designed for use under wet and severe conditions. If unit becomes wet it may cause you to receive an electric shock.

Precautions:

Use the product only in dry environments, for example in buildings or vehicles. Protect the product against humidity. If the product becomes humid, it must not be used!



Warning

If you open the product, either of the following actions may cause you to receive an electric shock.

- Touching live components
- Using the product after incorrect attempts were made to carry out repairs.

Precautions:

Do not open the product. Only GeoMax authorised service workshops are entitled to repair these products.

7.6 Laser Classification

7.6.1 General

General

The following directions (in accordance with the state of the art - international standard IEC 60825-1 (2007-03) and IEC TR 60825-14 (2004-02)) provide instruction and training information to the person responsible for the product and the person who actually uses the equipment, to anticipate and avoid operational hazards.

The person responsible for the product must ensure that all users understand these directions and adhere to them.



Products classified as laser class 1, class 2 and class 3R do not require:

- laser safety officer involvement,
- protective clothes and eyewear,
- special warning signs in the laser working area

if used and operated as defined in this user manual due to the low eye hazard level.



Products classified as laser class 2 or class 3R may cause dazzle, flash-blindness and afterimages, particularly under low ambient light conditions.

7.6.2 Laser Plummet

General

The laser plummet built into the product produces a visible red laser beam which emerges from the bottom of the product.

The laser product described in this section, is classified as laser class 2 in accordance with:

- IEC 60825-1 (2007-03): "Safety of laser products".
- EN 60825-1 (2007-10): "Safety of laser products".

Class 2 laser products:

These products are safe for momentary exposures but can be hazardous for deliberate staring into the beam.

Description	Value
Maximum radiant power	0.95 mW
Pulse duration	c.w.
Pulse repetition frequency	c.w.
Wavelength	650 nm - 660 nm

Warning

From a safety perspective class 2 laser products are not inherently safe for the eyes.

Precautions:

Avoid staring into the beam or pointing the beam at other people.

Labelling

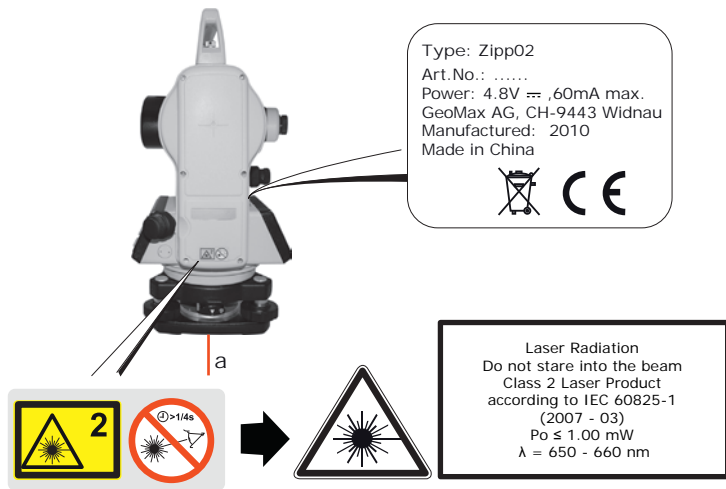

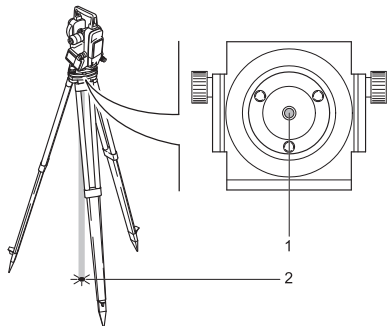

- 1 Exit for laser beam
- 2 Laser beam

7.7 Electromagnetic Compatibility EMC

Description

The term Electromagnetic Compatibility is taken to mean the capability of the product to function smoothly in an environment where electromagnetic radiation and electrostatic discharges are present, and without causing electromagnetic disturbances to other equipment.

 **Warning**

Electromagnetic radiation can cause disturbances in other equipment.

Although the product meets the strict regulations and standards which are in force in this respect, GeoMax cannot completely exclude the possibility that other equipment may be disturbed.

 **Caution**

There is a risk that disturbances may be caused in other equipment if the product is used with accessories from other manufacturers, for example field computers, personal computers, two-way radios, non-standard cables or external batteries.

Precautions:

Use only the equipment and accessories recommended by GeoMax. When combined with the product, they meet the strict requirements stipulated by the guidelines and standards. When using computers and two-way radios, pay attention to the information about electromagnetic compatibility provided by the manufacturer.

 **Caution**

Disturbances caused by electromagnetic radiation can result in erroneous measurements.

Although the product meets the strict regulations and standards which are in force in this respect, GeoMax cannot completely exclude the possibility that the product may be disturbed by intense electromagnetic radiation, for example, near radio transmitters, two-way radios or diesel generators.

Precautions:

Check the plausibility of results obtained under these conditions.

 **Warning**

If the product is operated with connecting cables attached at only one of their two ends, for example external supply cables, interface cables, the permitted level of electromagnetic radiation may be exceeded and the correct functioning of other products may be impaired.

Precautions:

While the product is in use, connecting cables, for example product to external battery, product to computer, must be connected at both ends.

8 Technical Data

8.1 Technical Data of the Instrument

Telescope

Image:	Erect
Magnification ratio:	30x
Effective aperture of object lense:	45 mm
Angle of view:	1°30'
Shortest visibility distance:	1.35 m
Stadia multiplication constant:	100
Stadia addition constant:	0
Resolution:	3"

Angle Measuring System

Mode of angle measurement:	Photoelectric incremental reading
Minimum reading:	1", 5"
Detection method:	H: Dual side V: Single side
Precision of angle measurement:	2"
Unit of angle:	DEG, MIL, GON
Display:	LCD double side

Compensator

Tilt sensor:	Automatic vertical compensation
Range of compensation:	±3'

Laser plummet

Optical diameter:	≤ 2mm
Maximum radiant power:	0.95 mW

Sensitivity of vial

Tubular vial:	30" / 2 mm
Circular vial:	8' / 2 mm

Environmental specifications

Operating temperature:	0° C to +50° C
Storage temperature:	-20° C to +50° C
Protected against dust, sand and rain	
Humidity:	Max. 90% non condensing The effects of condensation are to be effectively counteracted by periodically drying out the instrument.

Power Supply

Type	Voltage	Operating time, typical
Alkaline batteries	4.8 V	36 h (with alkaline batteries)
Rechargeable Ni-MH batteries		

Dimensions

Height [mm]	Width [mm]	Length [mm]
340	164	154

Weight

Weight of instrument: 4.6 kg
(with batteries)

8.2 Conformity to National Regulations

Conformity to national regulations

Hereby, GeoMax AG, declares that the instrument is in compliance with the essential requirements and other relevant provisions of applicable European Directives. The declaration of conformity is available from GeoMax AG.

9 International Limited Warranty

International Limited Warranty

This product is subject to the terms and conditions set out in the International Limited Warranty which you can download from the GeoMax home page at <http://www.geomax-positioning.com> or collect from your GeoMax distributor.

The foregoing warranty is exclusive and is in lieu of all other warranties, terms or conditions, express or implied, either in fact or by operation of law, statutory or otherwise, including warranties, terms or conditions of merchantability, fitness for a particular purpose, satisfactory quality and non-infringement, all of which are expressly disclaimed.



10 Accessories

List of accessories

- 1 set of plumb bob
 - 1 tool kit (containing a screw driver and 2 needles)
 - 2 bags of desiccant
 - 1 rain cover
 - 1 instruction manual
 - 1 charger
 - AA-battery case
 - 1 Ni-MH battery pack
 - 1 allen key
-

11 Error Information

Error codes

Display	Meaning and dealing method
E01	Count error,if displayed repetitively, repair is needed.
TOO FAST	The telescope or collimation unit rotated too fast, press any button except ON/OFF and  , the instrument returns to normal state.
E04	Horizontal sensor I error, repair is needed.
E05	Horizontal sensor II error, repair is needed.
E06	Vertical sensor error, repair is needed.
TILT	the tilt sensor out of range, level the instrument again, if invain, repair is needed.  Set off the tilt sensor, the instrument can work also.

GeoMax Zipp02



784192-1.1.0en, Original text

© 2011 GeoMax AG, Widnau, Switzerland